

# SFO083

0.5 – 25 GHz SLCFET  
SPDT Switch

## PRODUCT OVERVIEW

The SFO083 is a Single-Pole Double-Throw (SPDT) switch fabricated on ATL's Super Lattice Castellated-Gate Field Effect Transistor (SLCFET) 3S production process. The SFO083 is offered as a bare die to be wire bonded in the next higher assembly.

## PIN OUT

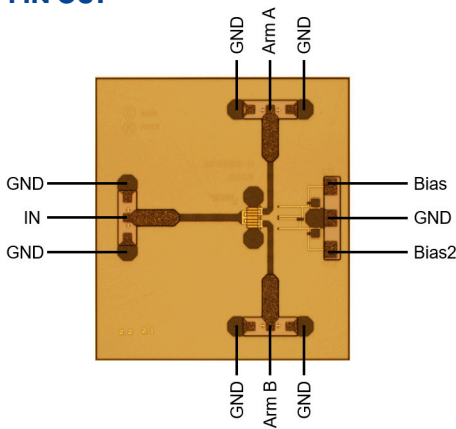

## FUNCTIONAL DIAGRAM

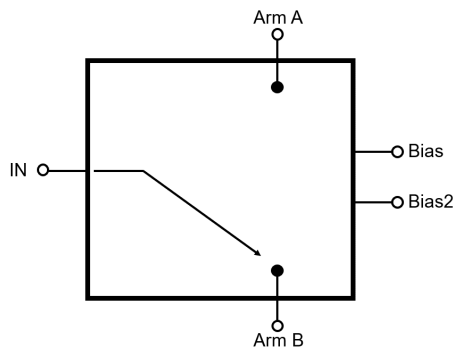

## KEY FEATURES

- SPDT
- Frequency Range: 0.5 – 25 GHz
- Temperature Range: -40 °C to 85 °C
- Insertion Loss: 0.38 dB typical
- Input Isolation: 26.4 dB
- Control Voltages: 0 to -14V typical
- Die dimensions: 1330 μm x 1340 μm
- Input 3rd Order Intercept Point (IIP3): 62.8 dBm

## TRUTH TABLE

Bias	Bias2	Signal Path State
Low	High	Arm A
High	Low	Arm B

States not listed in this table will operate at <100 ns.

## RECOMMENDED OPERATING CONDITIONS

Parameter	Min	Typ	Max	Units
Low Voltage		-14		V
High Voltage		0		V
Ambient Temperature	-40	25	85	°C

## ABSOLUTE MAXIMUM RATINGS

Parameter	Rating
Control Supply Current	<20 nA
Input Power (Pin) CW mode	32 dBm

## ELECTRICAL SPECIFICATIONS

Parameter	Min	Typ	Max	Units
Frequency	0.5		25	GHz
Insertion Loss		0.38		dB
Input Return Loss		31.5		dB
Output Return Loss		27.1		dB
Input Isolation		26.4		dB
Output Isolation		22		dB

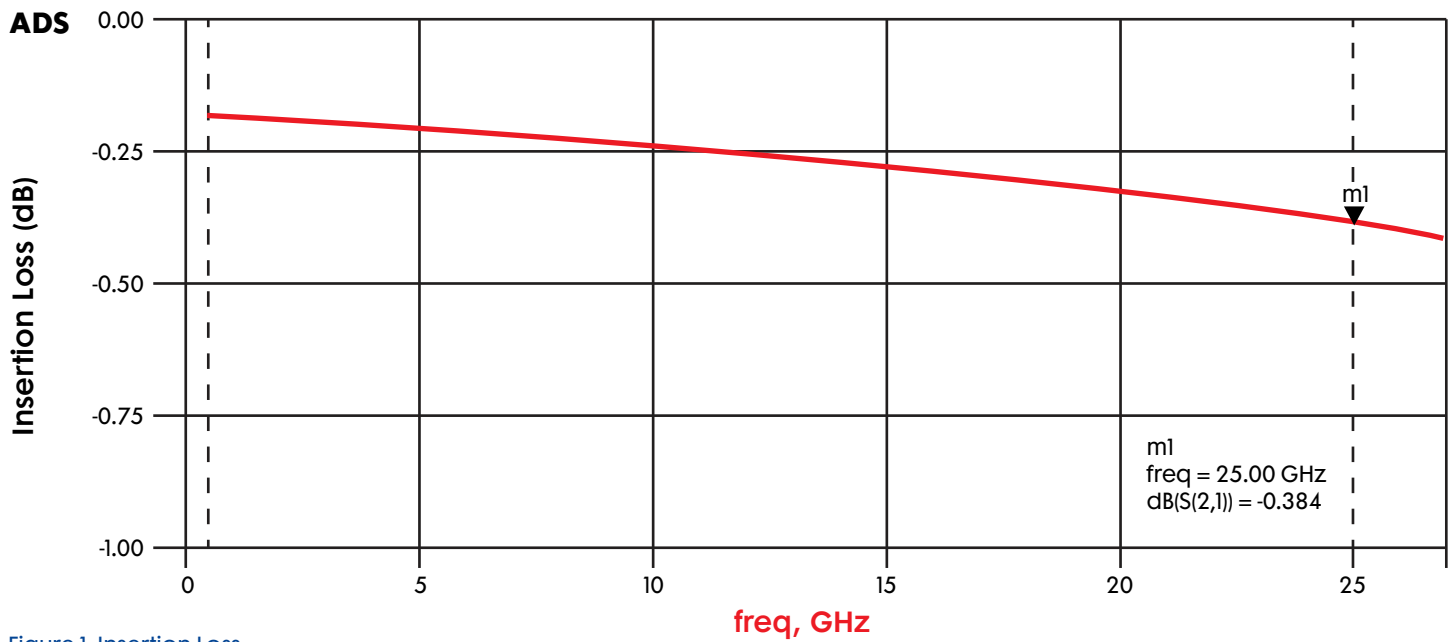

Figure 1. Insertion Loss

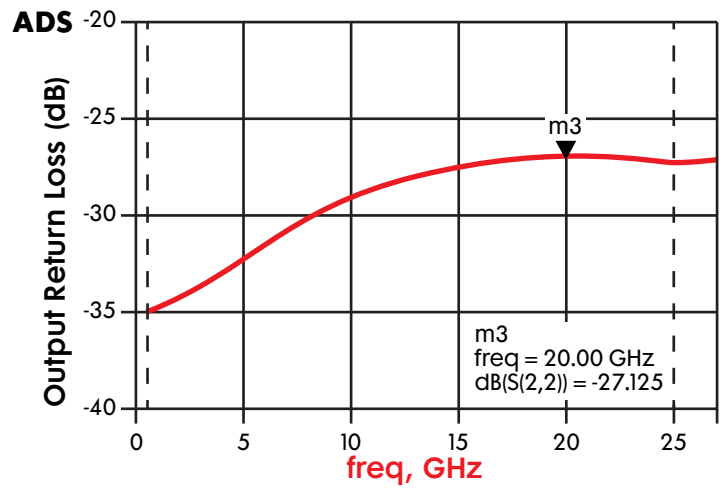
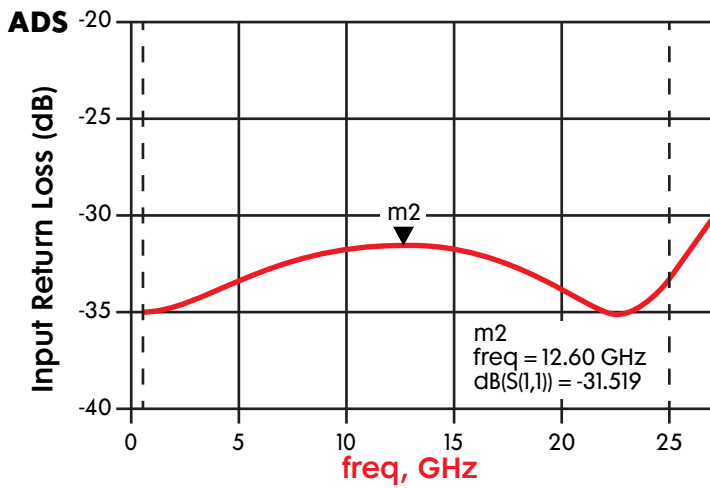

Figure 2. Input and Output Return Losses

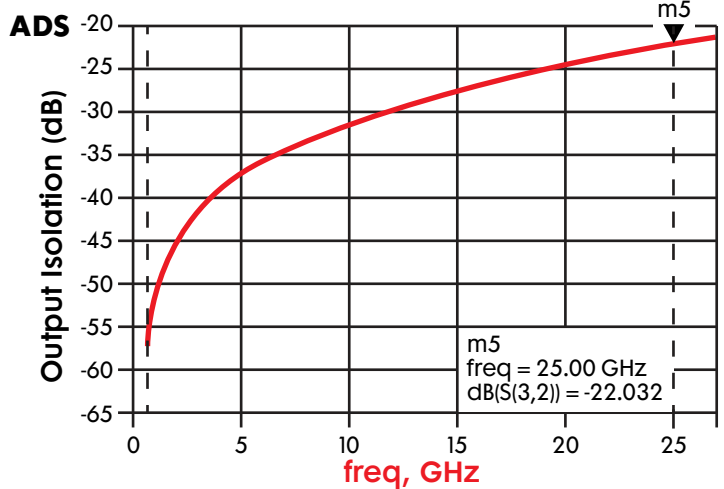
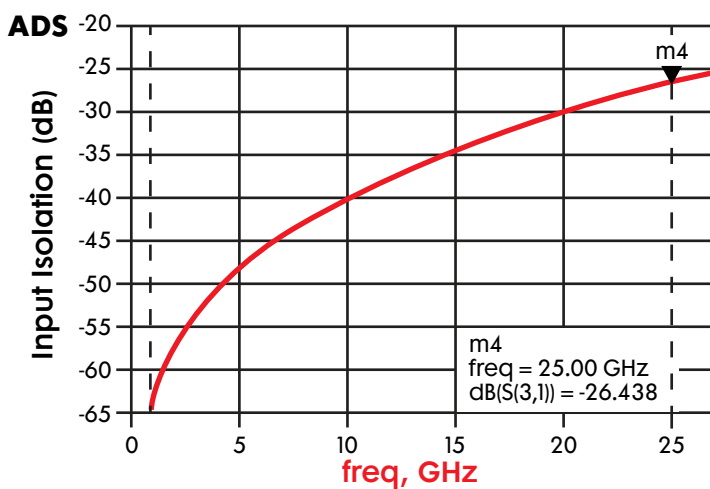

Figure 3. Input and Output Isolation