

## APN173 34-36 GHz GaN Power Amplifier

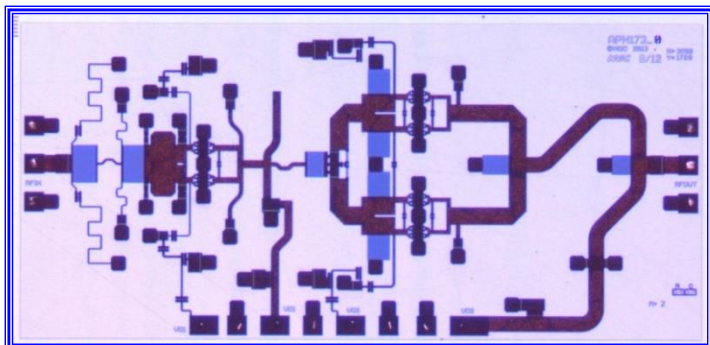
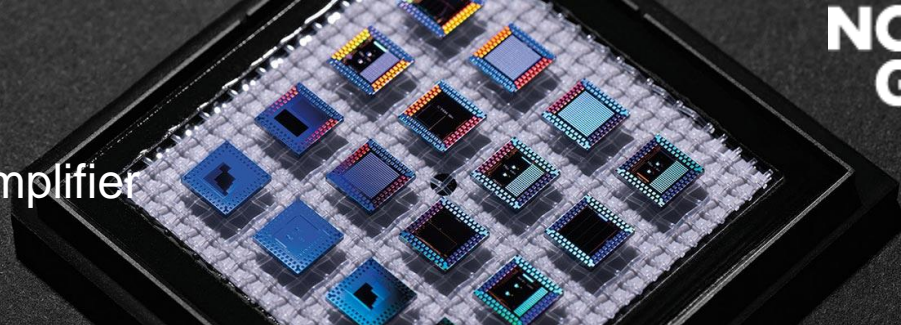

X = 3.65 mm Y = 2.72 mm

### Product Features

- RF frequency: 34 to 36 GHz
- Linear Gain: 19.5 dB typ.
- Psat: 37.5 dBm typ.
- PAE Max @ 25% typ.
- Die Size: < 6.3 sq. mm.
- 0.2 um GaN HEMT
- 4 mil SiC substrate
- DC Power: 28 VDC @ 432 mA

### Applications

- Military Radar Systems

**Not suitable for all applications.  
May not meet specific MilSpec requirements.**

### Product Description

The APN173 monolithic GaN HEMT amplifier is a broadband, two-stage power device, designed for use in Military Radar Systems. To ensure rugged and reliable operation, HEMT devices are fully passivated. Both bond pad and backside metallization are Au-based that is compatible with epoxy and eutectic die attach methods.

#### Performance Characteristics (Ta = 25°C)

Specification	Min	Typ	Max	Unit
Frequency	34		36	GHz
Linear Gain	18	19.5		dB
Input Return Loss	4.5	6		dB
Output Return Loss	10	13		dB
P1db		TBD		dBm
Psat	37	37.5		dBm
PAE @ Psat		24		%
Max PAE		25		%
Vd1, Vd2	20		28	V
Vg1		-4.5		V
Vg2		-4.5		V
Id1		144		mA
Id2		288		mA

Preliminary Information: The data contained in this document describes new products in the sampling or preproduction phase of development and is for information only. Northrop Grumman reserves the right to change without notice the characteristic data and other specifications as they apply to this product. The product represented by this datasheet is subject to U.S. Export Law as contained the EAR regulations

# APN173

## 34-36 GHz

### GaN Power Amplifier

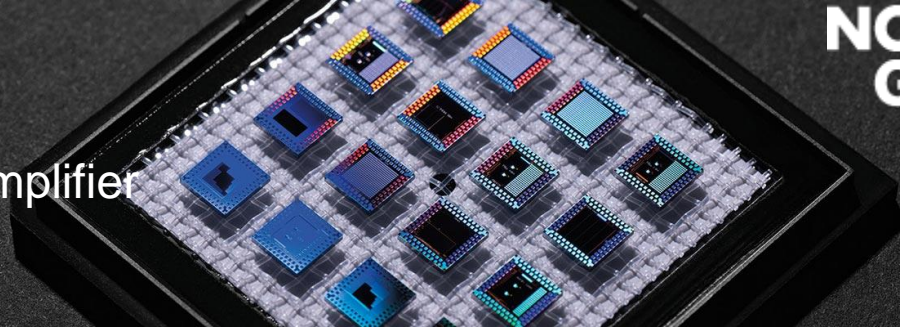

### On wafer measured Performance Characteristics (Typical Performance at 25°C)

Vd = 28 V, Id1 = 144 mA, Id2 = 288 mA. \*

GAIN vs. Frequency

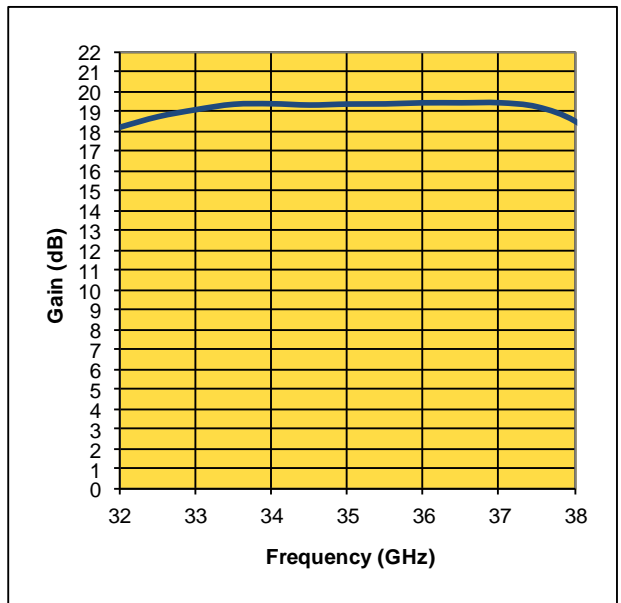

PAE, GAIN, Pout vs. Frequency

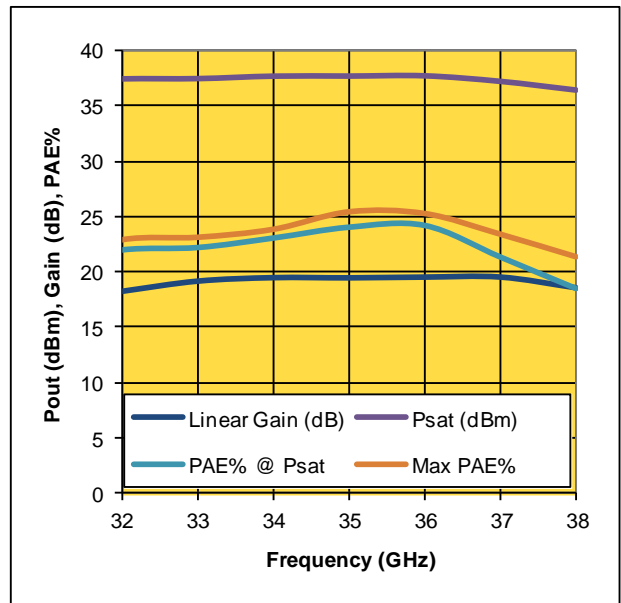

Input Return Loss vs. Frequency

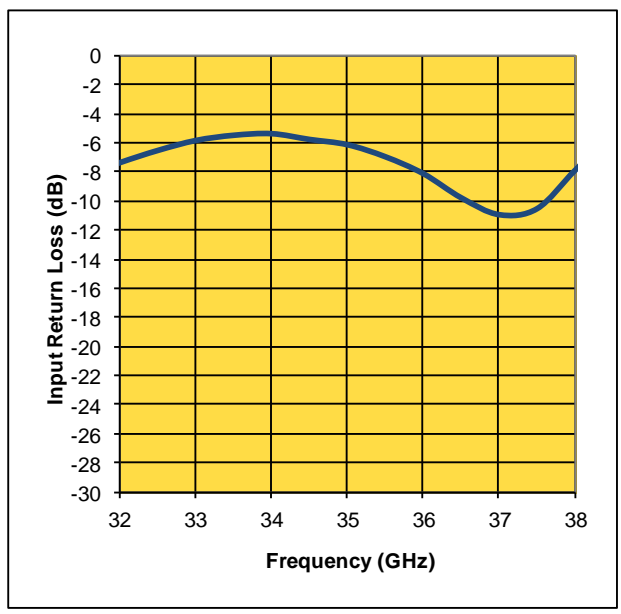

Output Return Loss vs. Frequency

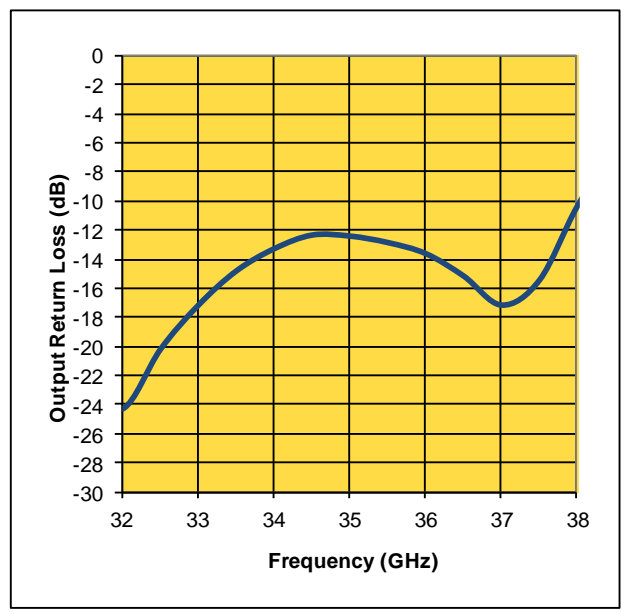

\*Pulsed-power on-wafer

Preliminary Information: The data contained in this document describes new products in the sampling or preproduction phase of development and is for information only. Northrop Grumman reserves the right to change without notice the characteristic data and other specifications as they apply to this product. The product represented by this datasheet is subject to U.S. Export Law as contained the EAR regulations

## APN173 34-36 GHz GaN Power Amplifier

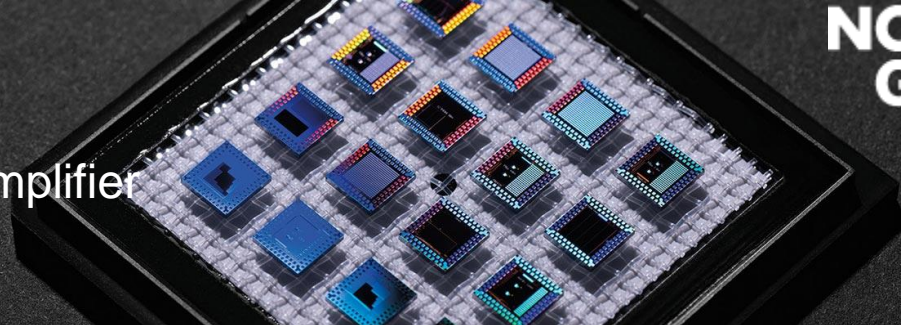

### Die Size and Bond Pad Locations (Not to Scale)

X =  $3650 \mu\text{m} \pm 25 \mu\text{m}$   
 Y =  $1720 \pm 25 \mu\text{m}$   
 DC Bond Pad =  $100 \times 100 \pm 0.5 \mu\text{m}$   
 RF Bond Pad =  $100 \times 100 \pm 0.5 \mu\text{m}$   
 Chip Thickness =  $101 \pm 5 \mu\text{m}$

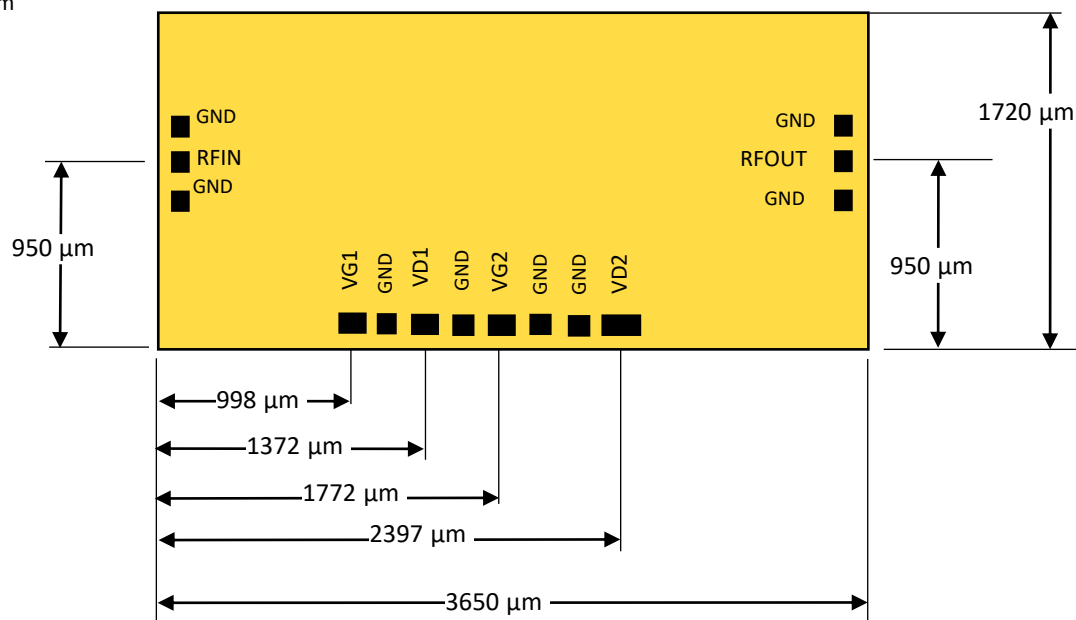

### Biasing/De-Biasing Details:

Listed below are some guidelines for GaN device testing and wire bonding:

- a. Limit positive gate bias (G-S or G-D) to  $< 1\text{V}$
- b. Know your devices' breakdown voltages
- c. Use a power supply with both voltage and current limit.
- d. With the power supply off and the voltage and current levels at minimum, attach the ground lead to your test fixture.
  - i. Apply negative gate voltage ( $-5\text{V}$ ) to ensure that all devices are off
  - ii. Ramp up drain bias to  $\sim 10\text{V}$
  - iii. Gradually increase gate bias voltage while monitoring drain current until 20% of the operating current is achieved
  - iv. Ramp up drain to operating bias
  - v. Gradually increase gate bias voltage while monitoring drain current until the operating current is achieved
- e. To safely de-bias GaN devices, start by debiasing output amplifier stages first (if applicable):
  - i. Gradually decrease drain bias to  $0\text{V}$ .
  - ii. Gradually decrease gate bias to  $0\text{V}$ .
  - iii. Turn off supply voltages
- f. Repeat de-bias procedure for each amplifier stage

Preliminary Information: The data contained in this document describes new products in the sampling or preproduction phase of development and is for information only. Northrop Grumman reserves the right to change without notice the characteristic data and other specifications as they apply to this product. The product represented by this datasheet is subject to U.S. Export Law as contained the EAR regulations

## APN173 34-36 GHz GaN Power Amplifier

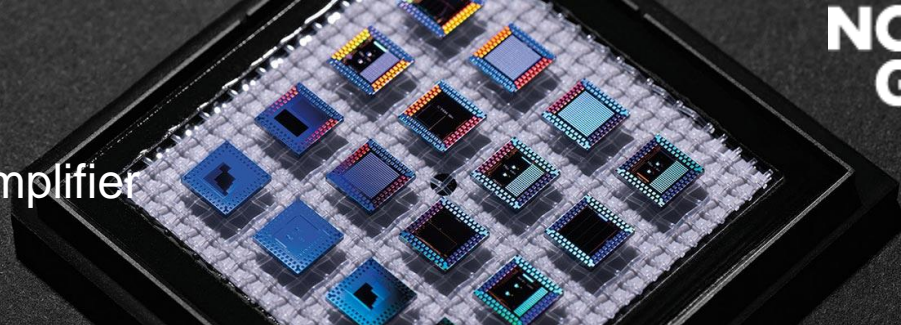

### Suggested Bonding Arrangement

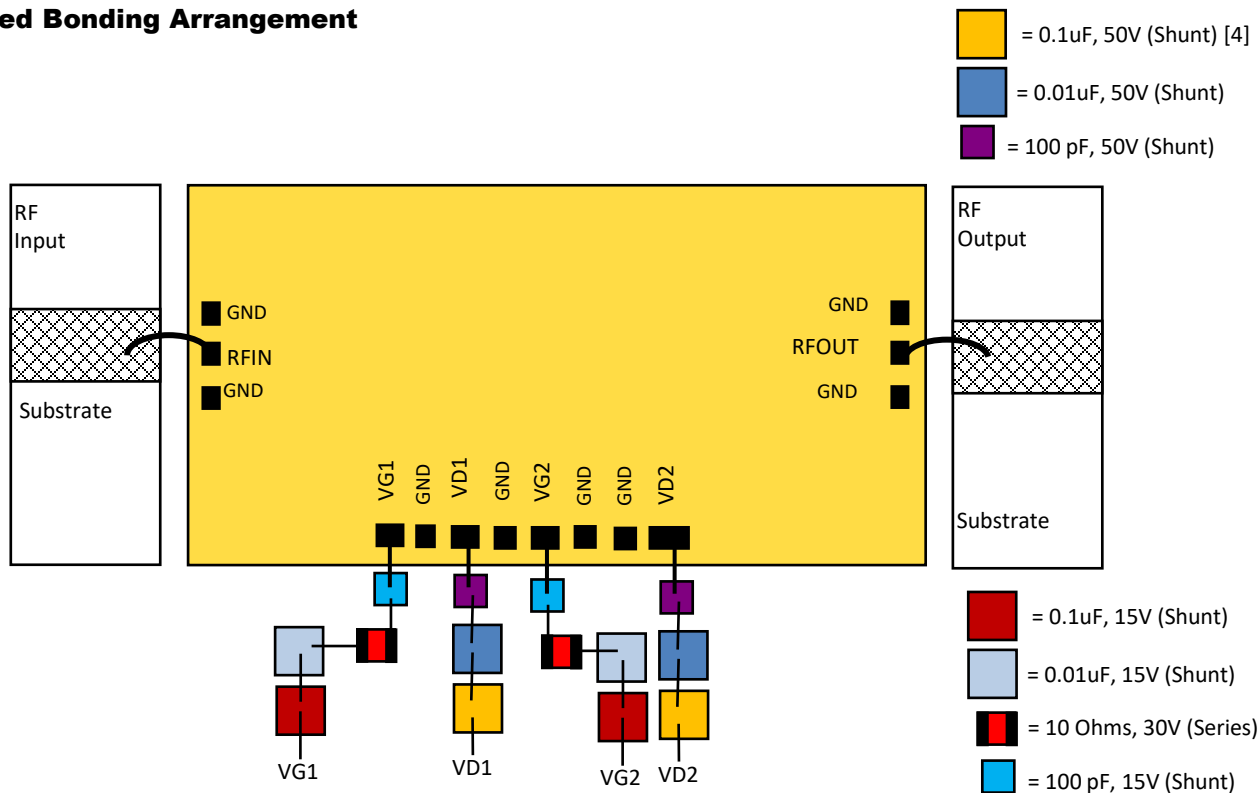

### Recommended Assembly Notes

1. Bypass caps should be 100 pF (approximately) ceramic (single-layer) placed no farther than 30 mils from the amplifier.
2. Best performance obtained from use of <10 mil (long) by 3 by 0.5 mil ribbons on input and output.
3. Part must be biased from both sides as indicated.
4. The 0.1uF, 50V capacitors are not needed if the drain supply line is clean. If Drain Pulsing of the device is to be used, do **NOT** use the 0.1uF, 50V Capacitors.

### Mounting Processes

Most NGAS GaN IC chips have a gold backing and can be mounted successfully using either a conductive epoxy or AuSn attachment. NGAS recommends the use of AuSn for high power devices to provide a good thermal path and a good RF path to ground. Maximum recommended temp during die attach is 320°C for 30 seconds.

**Note:** Many of the NGAS parts do incorporate airbridges, so caution should be used when determining the pick up tool.

**CAUTION:** THE IMPROPER USE OF AuSn ATTACHMENT CAN CATASTROPHICALLY DAMAGE GaN CHIPS.

**PLEASE ALSO REFER TO OUR “GaN Chip Handling Application Note” BEFORE HANDLING, ASSEMBLING OR BIASING THESE MMICS!**

Preliminary Information: The data contained in this document describes new products in the sampling or preproduction phase of development and is for information only. Northrop Grumman reserves the right to change without notice the characteristic data and other specifications as they apply to this product. The product represented by this datasheet is subject to U.S. Export Law as contained the EAR regulations