

APN279

16 – 20.5 GHz
GaN Power Amplifier

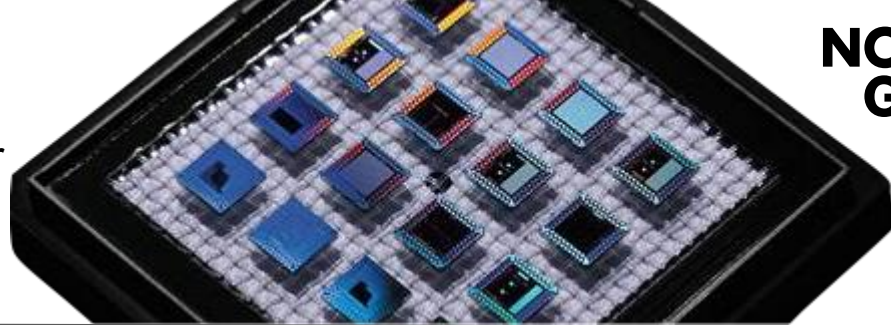

Revision 2022-1

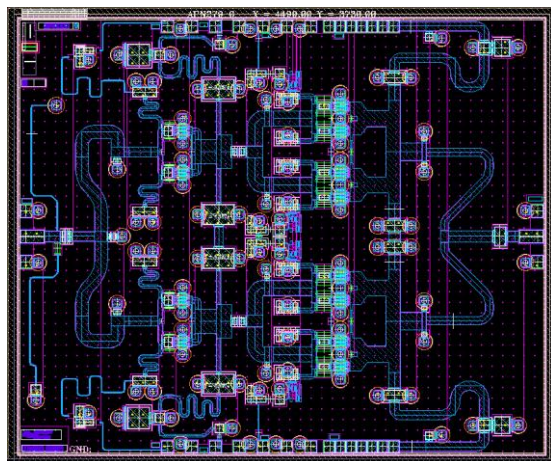

X = 4.49 mm Y = 3.73 mm

Product Description

The APN279 monolithic GaN HEMT amplifier is a broadband, two-stage power device, designed for use in Point-to-Point and Multipoint Digital Radios, Commercial SatCom. To ensure rugged and reliable operation, HEMT devices are fully passivated. Both bond pad and backside metallization are Au-based that is compatible with epoxy and eutectic die attach methods.

Applications

- Point-to-Point Radio
- Multipoint Digital Radios
- Commercial SatCom

Product Features

- RF Frequency: 16 to 20.5 GHz
- Linear gain: 19 dB, typical
- OP1dB: 36 dBm, typical
- Psat: 41.5dBm, typical
- PAE: >34% @ Psat
- DC Power: 20 Vdc at 712 mA
- Size: 4490 um x 3730 um
- Technology: 0.20 um GaN HEMT

Export Information

ECCN: **3A001.b.2.c**

HTS (Schedule B) code: **8542330001**

Preliminary Information: The data contained in this document describes new products in the sampling or preproduction phase of development and is for information only. Northrop Grumman reserves the right to change without notice the characteristic data and other specifications as they apply to this product. The product represented by this datasheet is subject to the U.S. Export Law as contained in the EAR regulations.

Web: <http://www.yeswegan.com>

©2015 Northrop Grumman Systems Corporation

Phone: (310) 814-5000 • Fax: (310) 812-7011 • E-mail: as-mps.sales@ngc.com

Approved for Public Release: NG22-0331 © 2022, Northrop Grumman

APN279

16 – 20.5 GHz
GaN Power Amplifier

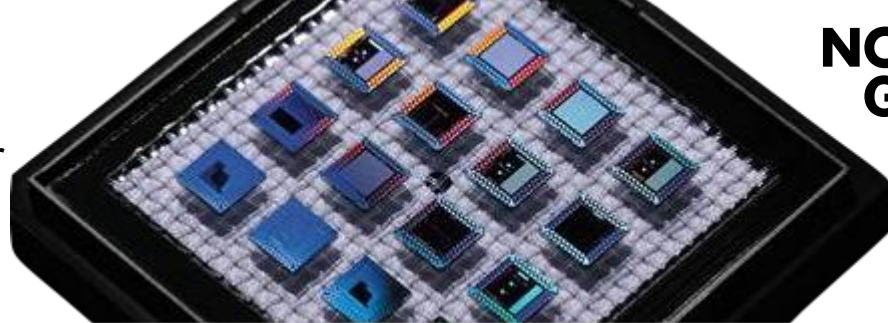

Revision 2022-1

Absolute Maximum Ratings

Parameter	Value	Unit
Drain Voltage	28	V
Gate Voltage Range	-8 to 0	V
Drain Current	1.78	A
Gate Current	0.7	mA
Power Dissipation, 30C	51.4	W
Soldering Temperature	320	°C

Recommended Operating Conditions

Parameter	Value	Unit
Drain Voltage Range	20 - 26	V
Gate Voltage Range	-5 to -3	V
Stg 1 Drain Current (Idq)	200	mA
Stg 2 Drain Current (Idq)	512	mA

Electrical Specifications

Parameter	Min	Typ	Max	Unit
Operational Frequency	16		20.5	GHz
Small Signal at 28V				
Small Signal Linear Gain	15	18	19	dB
Input Return Loss	-14		-2	dB
Output Return Loss	-14		-4	dB
On-Wafer Pulsed Power at 28V				
Psat (at 25 dBm)	40	41	41.5	dBm
Power Gain (at 25 dBm)	15.7	16	16.5	dB
P1db	37	40	41.3	dBm
PAE (at 25 dBm)	34	38.4	42.6	%
Max PAE	34	39.2	42.6	%
Fixtured CW at 28V, 25°C Case Temp				
Psat (at 25 dBm)	40.3	40.6	40.8	dBm
Power Gain (at 25 dBm)	16.6	17.3	18.8	dB
PAE (at 25 dBm)	26.4	27.6	29.7	%
Max PAE	26.5	28.6	30.3	%
Drain Voltage		28		V
Stage 1 Gate Voltage		-4.092		V
Stage 2 Gate Voltage		-4.106		V
Stage 1 Idq		200		mA
Stage 2 Idq		512		mA

* On-wafer ** Fixture

Preliminary Information: The data contained in this document describes new products in the sampling or preproduction phase of development and is for information only. Northrop Grumman reserves the right to change without notice the characteristic data and other specifications as they apply to this product. The product represented by this datasheet is subject to the U.S. Export Law as contained in the EAR regulations.

Web: <http://www.yeswegan.com>

©2015 Northrop Grumman Systems Corporation

Phone: (310) 814-5000 • Fax: (310) 812-7011 • E-mail: as-mps.sales@ngc.com

Approved for Public Release: NG22-0331 © 2022, Northrop Grumman

APN279

16 – 20.5 GHz
GaN Power Amplifier

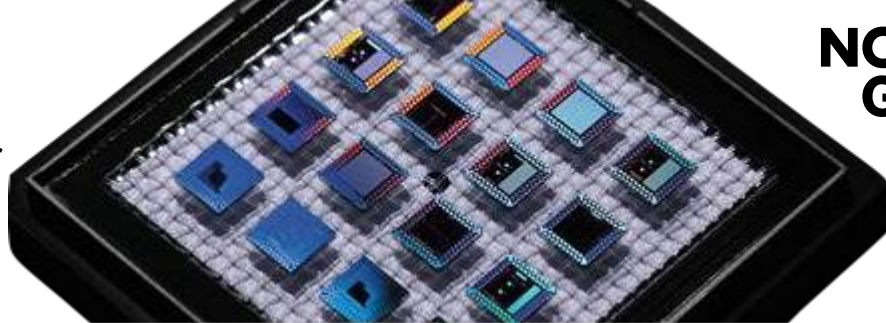

Revision 2022-1

Pulsed On-wafer measured Performance Characteristics (Typical Performance at 25°C) Vd = 20 V, Id1 = 200 mA, Id2 = 512 mA.*

Small Signal GAIN vs. Frequency

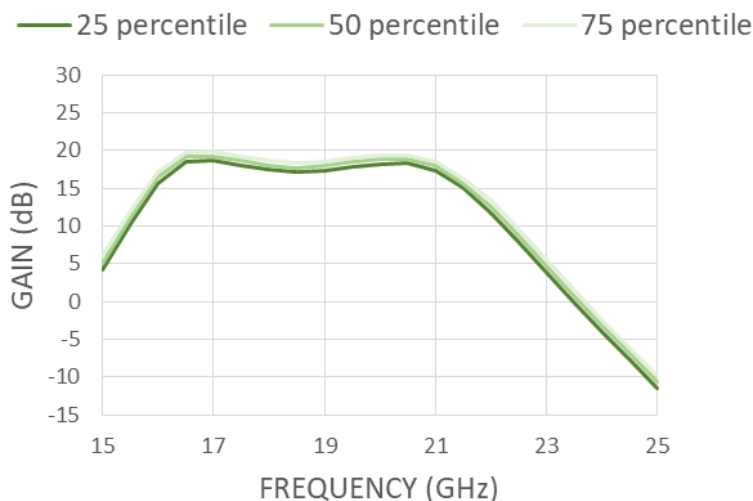

Large Signal PAE, GAIN, PSAT vs. Frequency

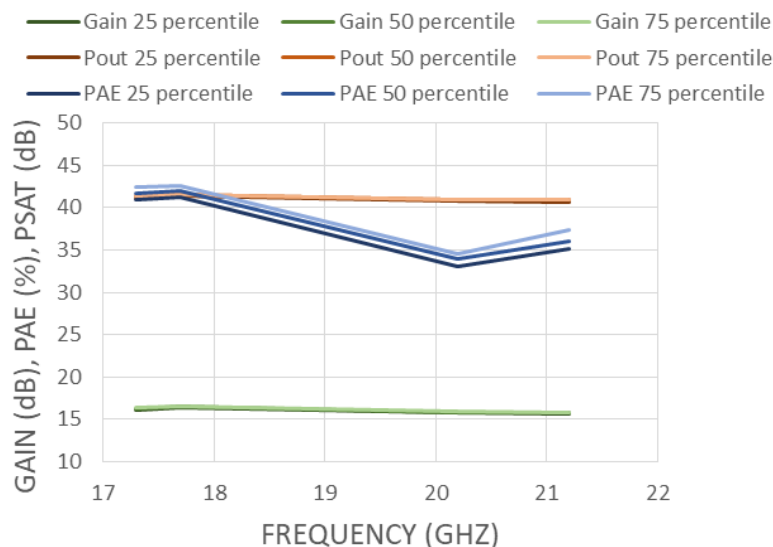

Input Return Loss vs. Frequency

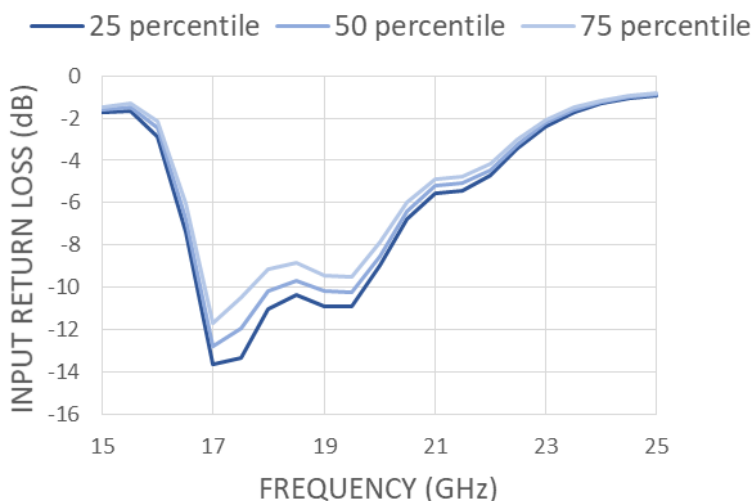

Output Return Loss vs. Frequency

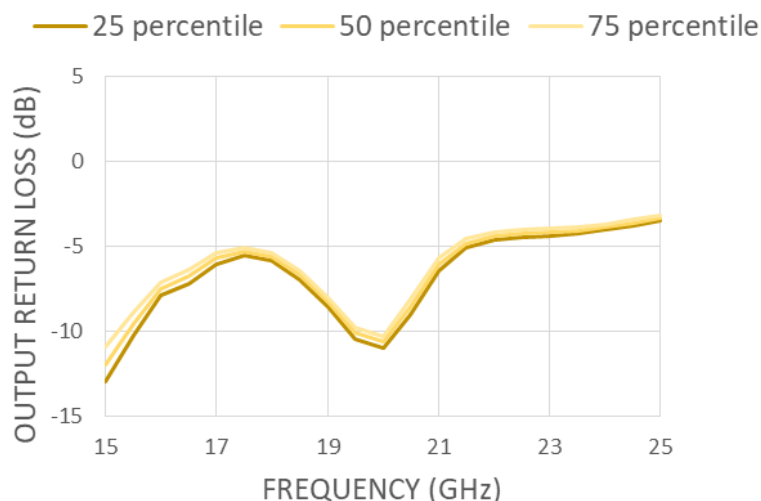

Preliminary Information: The data contained in this document describes new products in the sampling or preproduction phase of development and is for information only. Northrop Grumman reserves the right to change without notice the characteristic data and other specifications as they apply to this product. The product represented by this datasheet is subject to the U.S. Export Law as contained in the EAR regulations.

Web: <http://www.yeswegan.com>

©2015 Northrop Grumman Systems Corporation

Phone: (310) 814-5000 • Fax: (310) 812-7011 • E-mail: as-mps.sales@ngc.com

Approved for Public Release: NG22-0331 © 2022, Northrop Grumman

APN279

16 – 20.5 GHz
GaN Power Amplifier

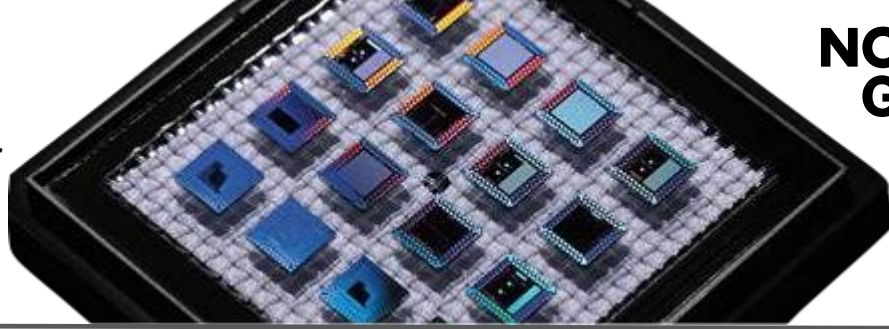

Revision 2022-1

Fixture Measured Performance Characteristics (Typical Performance at 25°C)

$V_d = 28.0\text{ V}$, $I_{d1} = 200\text{ mA}$, $I_{d2} = 512\text{ mA}$

POUT and GAIN vs. PIN

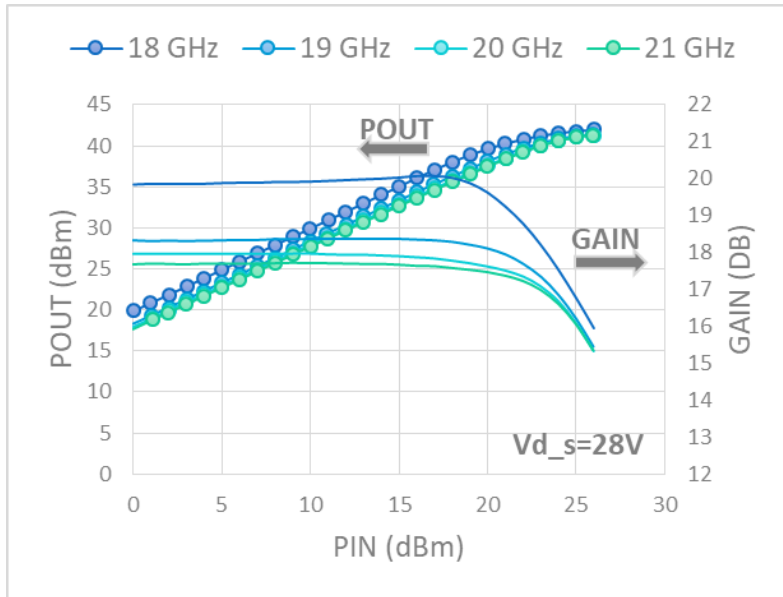

PAE, GAIN, POUT vs. FREQUENCY

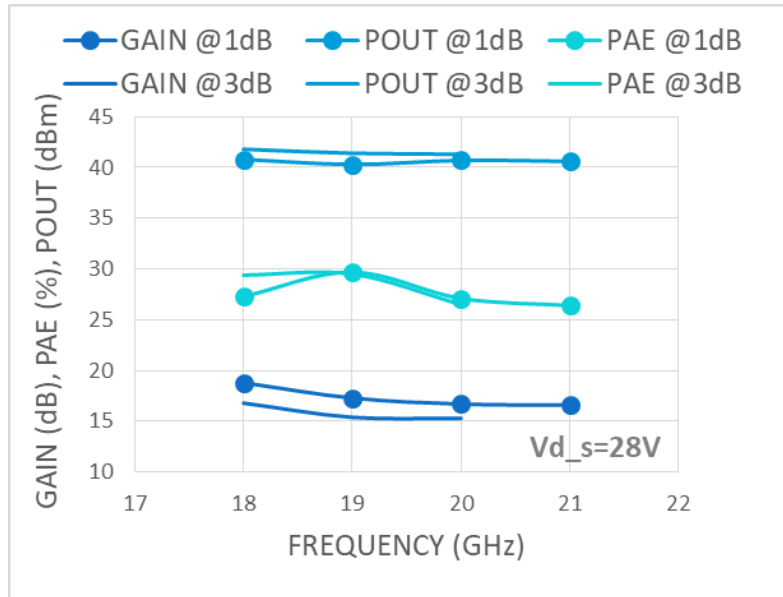

PAE vs PIN

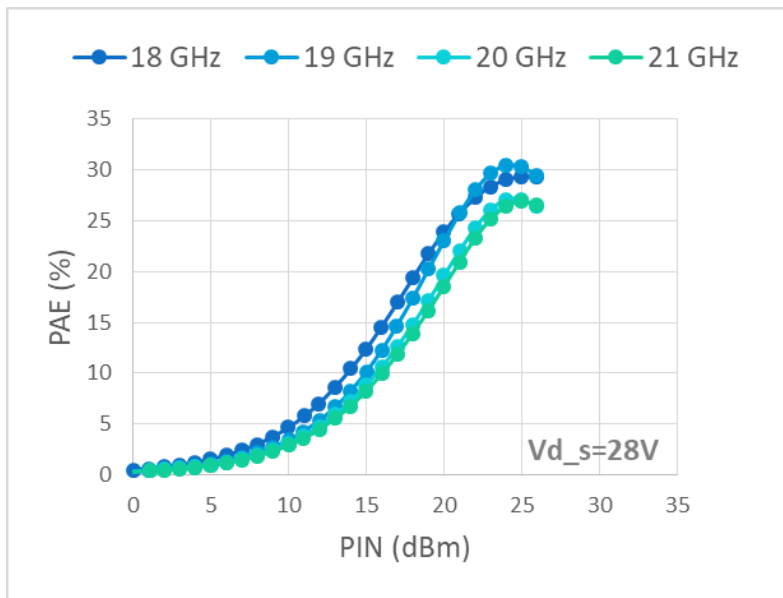

I_{d1} , I_{d2} vs PIN

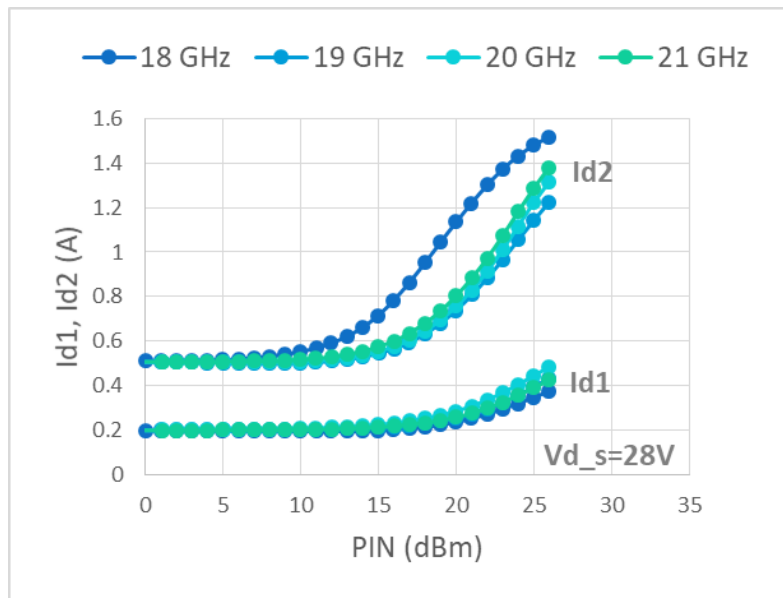

Preliminary Information: The data contained in this document describes new products in the sampling or preproduction phase of development and is for information only. Northrop Grumman reserves the right to change without notice the characteristic data and other specifications as they apply to this product. The product represented by this datasheet is subject to the U.S. Export Law as contained in the EAR regulations.

Web: <http://www.yeswegan.com>

©2015 Northrop Grumman Systems Corporation

Phone: (310) 814-5000 • Fax: (310) 812-7011 • E-mail: as-mps.sales@ngc.com

Approved for Public Release: NG22-0331 © 2022, Northrop Grumman

APN279

16 – 20.5 GHz
GaN Power Amplifier

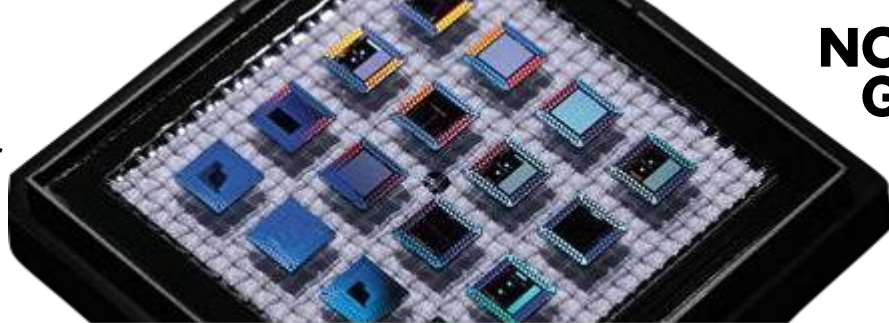

Revision 2022-1

Fixture measured Performance Characteristics (Typical Performance at 25°C)

$V_d = 24.0\text{ V}$, $I_{d1} + I_{d1a} = 520\text{ mA}$, $I_{d2} + I_{d2a} = 2100\text{ mA}$

AM-AM vs. PIN

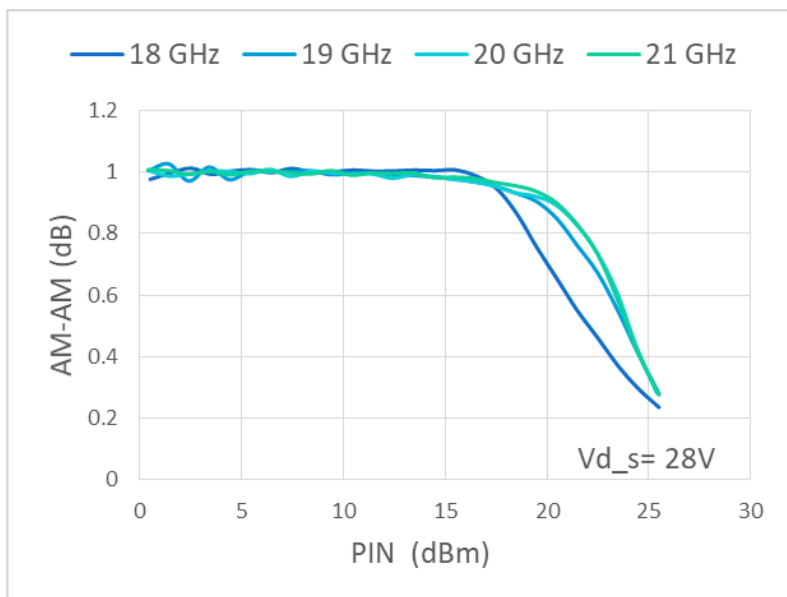

AM-PM vs. PIN

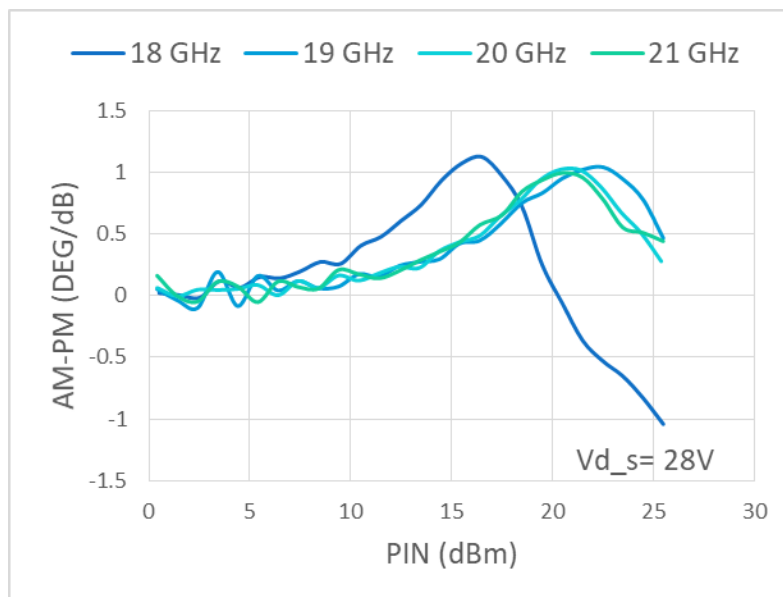

Preliminary Information: The data contained in this document describes new products in the sampling or preproduction phase of development and is for information only. Northrop Grumman reserves the right to change without notice the characteristic data and other specifications as they apply to this product. The product represented by this datasheet is subject to the U.S. Export Law as contained in the EAR regulations.

Web: <http://www.yeswegan.com>

©2015 Northrop Grumman Systems Corporation

Phone: (310) 814-5000 • Fax: (310) 812-7011 • E-mail: as-mps.sales@ngc.com

Approved for Public Release: NG22-0331 © 2022, Northrop Grumman

APN279

16 – 20.5 GHz
GaN Power Amplifier

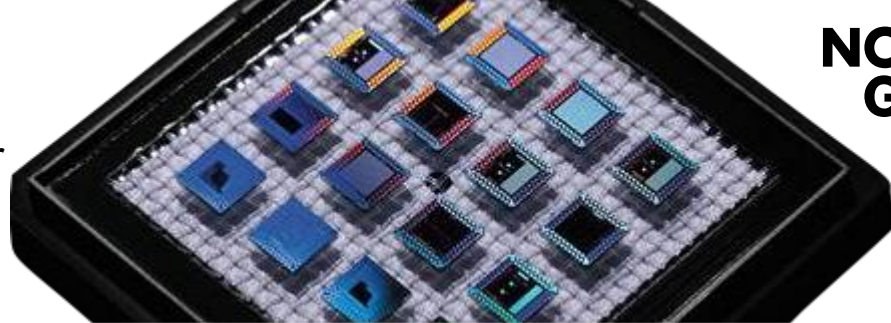

Revision 2022-1

Preliminary Thermal Properties with die mounted with 25um 80/20 AuSn Eutectic to: 10mil Cu10W Shim.

Shim	Mounting Material	Average Backside Die Temperature	Junction Temperature T _{jc} (°C)	RF Output (dBm)	Power Dissipation (W)	Thermal Resistance R _{jc} (°C/W)
10 mil CuW	AuSn Eutectic	30 °C	139	37.2	30.5	3.57
			154	40.0	33.1	3.74
			175	43.0	37.8	3.83
		50 °C	169	37.2	30.5	3.9
			185	40.0	33.1	4.09
			208	43.0	37.8	4.18
		70 °C	199	37.2	30.5	4.22
			217	40.0	33.1	4.43
			241	43.0	37.8	4.53
10 mil CuW	Ag Epoxy	30 °C	173	37.2	30.5	4.7
			195	40.0	33.1	4.97
			225	43.0	37.8	5.15
		50 °C	207	37.2	30.5	5.14
			231	40.0	33.1	5.46
			263	43.0	37.8	5.65
		70 °C	241	37.2	30.5	5.6
			266	40.0	33.1	5.9

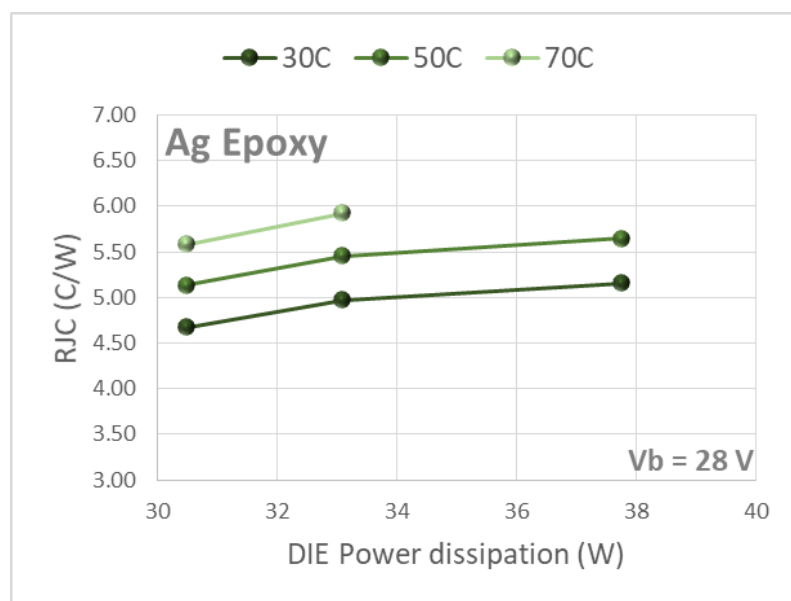
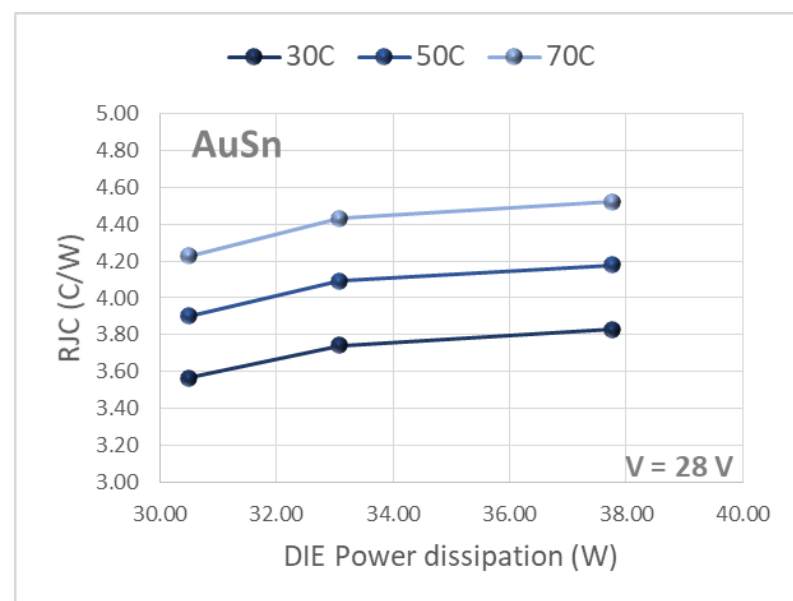

** V_d = 28.0 V, I_{dq1} = 200 mA, I_{d2q} = 512 mA

Preliminary Information: The data contained in this document describes new products in the sampling or preproduction phase of development and is for information only. Northrop Grumman reserves the right to change without notice the characteristic data and other specifications as they apply to this product. The product represented by this datasheet is subject to the U.S. Export Law as contained in the EAR regulations.

Web: <http://www.yeswegan.com>

©2015 Northrop Grumman Systems Corporation

Phone: (310) 814-5000 • Fax: (310) 812-7011 • E-mail: as-mps.sales@ngc.com

Approved for Public Release: NG22-0331 © 2022, Northrop Grumman

APN279

16 – 20.5 GHz

GaN Power Amplifier

**NORTHROP
GRUMMAN**

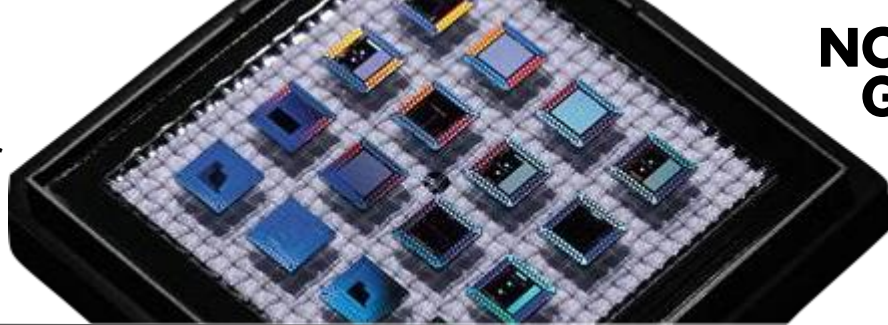

Revision 2022-1

Die Size and Bond Pad Locations (Not to Scale)

X = $3300 \mu\text{m} \pm 25 \mu\text{m}$

Y = $4100 \pm 25 \mu\text{m}$

DC Bond Pad = $100 \times 100 \pm 0.5 \mu\text{m}$

RF Bond Pad = $100 \times 200 \pm 0.5 \mu\text{m}$

Chip Thickness = $101 \pm 5 \mu\text{m}$

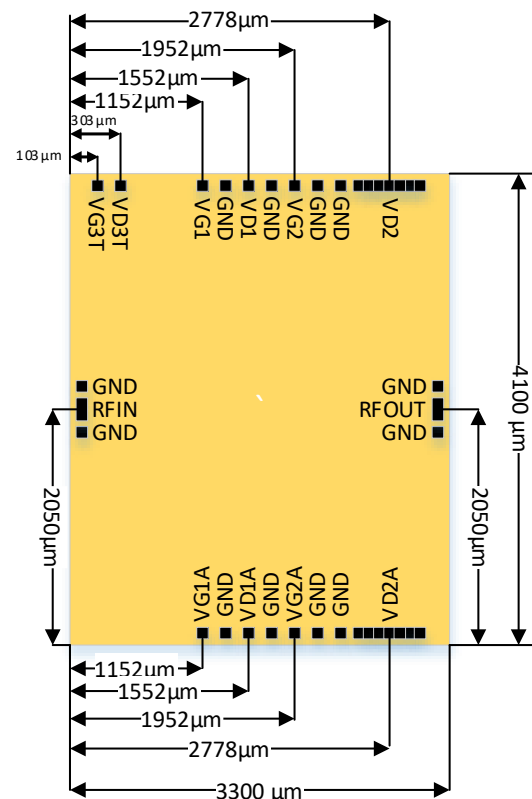

Biasing/De-Biasing Details:

Bias for 1st stage is from top. The 2nd stages must bias up from both sides.

Listed below are some guidelines for GaN device testing and wire bonding:

- Limit positive gate bias (G-S or G-D) to $< 1\text{V}$
- Know your devices' breakdown voltages
- Use a power supply with both voltage and current limit.
- With the power supply off and the voltage and current levels at minimum, attach the ground lead to your test fixture.
 - Apply negative gate voltage (-8V) to ensure that all devices are off
 - Ramp up drain bias to $\sim 10\text{V}$
 - Gradually increase gate bias voltage while monitoring drain current until 20% of the operating current is achieved
 - Ramp up drain to operating bias
 - Gradually increase gate bias voltage while monitoring drain current until the operating current is achieved
- To safely de-bias GaN devices, start by de-biasing output amplifier stages first (if applicable):
 - Set gate voltage back to pinch-off (-8V).
 - Gradually decrease drain bias to 0V .
 - Gradually decrease gate bias to 0V .
 - Turn off supply voltages
- Repeat de-bias procedure for each amplifier stage

Preliminary Information: The data contained in this document describes new products in the sampling or preproduction phase of development and is for information only. Northrop Grumman reserves the right to change without notice the characteristic data and other specifications as they apply to this product. The product represented by this datasheet is subject to the U.S. Export Law as contained in the EAR regulations.

Web: <http://www.yeswegan.com>

©2015 Northrop Grumman Systems Corporation

Phone: (310) 814-5000 • Fax: (310) 812-7011 • E-mail: as-mps.sales@ngc.com

Approved for Public Release: NG22-0331 © 2022, Northrop Grumman

APN279

16 – 20.5 GHz

GaN Power Amplifier

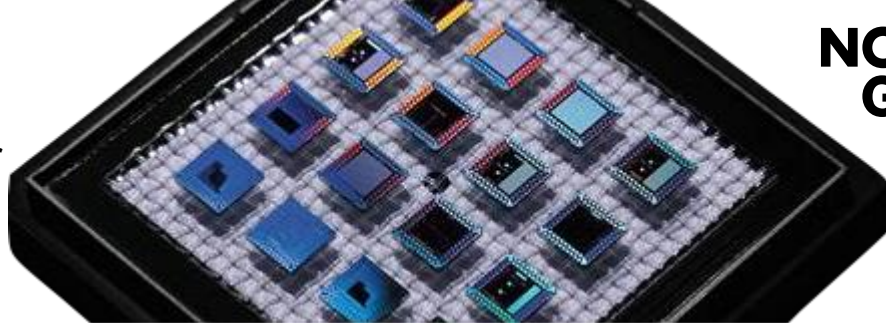

Revision 2022-1

Suggested Bonding Arrangement

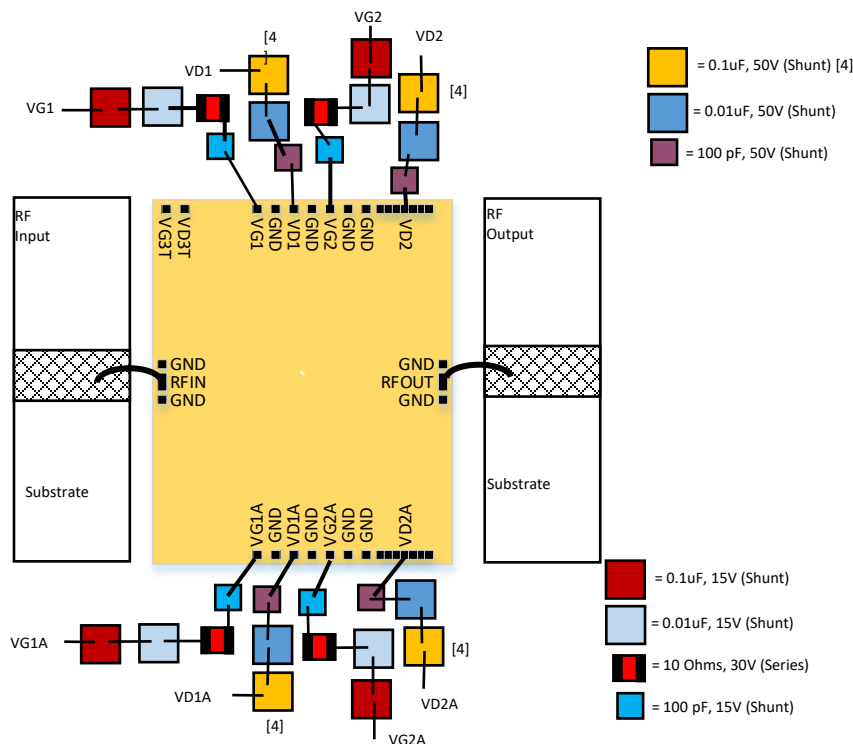

Recommended Assembly Notes

1. Bypass caps should be 100 pF (approximately) ceramic (single-layer) placed no farther than 30 mils from the amplifier.
2. Best performance obtained from use of <10 mil (long) by 3 by 0.5 mil ribbons on input and output.
3. Part must be biased from both sides as indicated.
4. The 0.1uF, 50V capacitors are not needed if the drain supply line is clean. If Drain Pulsing of the device is to be used, do **NOT** use the 0.1uF, 50V Capacitors.

Mounting Processes

Most NGSS GaN IC chips have a gold backing and can be mounted successfully using either a conductive epoxy or AuSn attachment. NGSS recommends the use of AuSn for high power devices to provide a good thermal path and a good RF path to ground. Maximum recommended temp during die attach is 320°C for 30 seconds.

Note: Many of the NGSS parts do incorporate airbridges, so caution should be used when determining the pick up tool.

CAUTION: THE IMPROPER USE OF AuSn ATTACHMENT CAN CATASTROPHICALLY DAMAGE GaN CHIPS.

PLEASE ALSO REFER TO OUR “GaN Chip Handling Application Note” BEFORE HANDLING, ASSEMBLING OR BIASING THESE MMICS!

Preliminary Information: The data contained in this document describes new products in the sampling or preproduction phase of development and is for information only. Northrop Grumman reserves the right to change without notice the characteristic data and other specifications as they apply to this product. The product represented by this datasheet is subject to the U.S. Export Law as contained in the EAR regulations.

Web: <http://www.yeswegan.com>

©2015 Northrop Grumman Systems Corporation

Phone: (310) 814-5000 • Fax: (310) 812-7011 • E-mail: as-mps.sales@ngc.com

Approved for Public Release: NG22-0331 © 2022, Northrop Grumman