



Minotaur IV • V • VI User's Guide

Release 2.4
September 2020

Approved for Public Release. Distribution Unlimited.
©2020 Northrop Grumman Corporation.
All Rights Reserved.
TMI7589_Cover

**NORTHROP
GRUMMAN**

This page left intentionally blank.

REVISION SUMMARY				
VERSION	DOCUMENT	DATE	CHANGE	PAGE
1.0	TM-17589	Jan 2005	Initial Release	All
1.1	TM-17589A	Jan 2006	General nomenclature, history, and administrative updates (no technical updates) 1. Updated launch history 2. Corrected contact information	All
2.0	TM-17589B	Jun 2013	Extensively Revised	All
2.1	TM-17589C	Aug 2015	Updated to current Orbital ATK naming.	All
2.2	TM-17589D	Aug 2015	Minor updates to correct Orbital ATK naming.	All
2.3	TM-17589E	Apr 2019	Branding update to Northrop Grumman. Corrected Figures 4.2.2-1 and 4.2.2-2. Corrected Section 6.2.1, paragraph 3.	All
2.4	TM-17589E	Sep 2020	Branding update. Updated contact information. Updated footer.	All

This page left intentionally blank.

The information provided in this user's guide is for initial planning purposes only. Information for development/design is determined through mission specific engineering analyses. The results of these analyses are documented in a mission-specific Interface Control Document (ICD) for the payload organization to use in their development/design process. This document provides an overview of the Minotaur system design and a description of the services provided to our customers.

For technical information and additional copies of this User's Guide, contact:

Northrop Grumman Space Systems Sector

Sector Headquarters

45101 Warp Drive
Dulles, VA 20166
+1 (703) 406-5000

www.northropgrumman.com

Launch and Missile Defense Systems Division Headquarters

1575 South Price Road
Chandler, AZ 85286
+1 (480) 899-6000

Warren Frick
Manager, Business Development
(703) 234-3935
Warren.Frick@ngc.com

Additional information can be obtained from the USAF OSP Office at:

US Air Force, Space and Missile Systems Center,
Advanced Systems and Development Directorate (SMC/AD)
Rocket Systems Launch Program (SMC/ADSL)
3548 Aberdeen Ave SE
Kirtland AFB, NM 87117-5778

(505) 853-5533

(505) 853-0507

PREFACE iii

GLOSSARY xi

1. INTRODUCTION 1

 1.1. Minotaur Family Performance and Capability 2

2. MINOTAUR IV CONFIGURATIONS 5

 2.1. Minotaur IV Launch System Overview 5

 2.2. Minotaur IV Launch Service 6

 2.3. Minotaur IV Launch Vehicle 6

 2.3.1. Stage 1, 2 and 3 Booster Assemblies 6

 2.3.2. Upper Stage Propulsion 7

 2.3.3. Guidance and Control Assembly (GCA) 8

 2.3.3.1. Avionics 9

 2.3.3.2. Attitude Control Systems 9

 2.3.3.3. Telemetry Subsystem 9

 2.3.4. Payload Interface 10

 2.3.5. Payload Fairing 11

 2.3.6. Minotaur IV Launch Vehicle Enhanced Performance Configurations 12

 2.3.6.1. Minotaur IV+ (STAR 48 Stage 4) 12

 2.3.6.2. Minotaur V (High Energy Performance) 13

 2.3.6.3. Minotaur VI 14

 2.3.6.4. Minotaur VI+ (High Energy Performance) 15

 2.4. Launch Support Equipment 15

3. GENERAL PERFORMANCE 19

 3.1. Mission Profiles 19

 3.2. Launch Sites 19

 3.2.1. Western Launch Sites 21

 3.2.2. Eastern Launch Sites 21

 3.2.3. Alternate Launch Sites 21

 3.3. Performance Capability 22

 3.3.1. Minotaur IV LEO Orbits 24

 3.3.2. Minotaur IV+ LEO Orbits 26

 3.3.3. Minotaur VI LEO Orbits 28

 3.3.4. Elliptical Orbits and High Energy Orbits 30

 3.4. Injection Accuracy 33

 3.5. Payload Deployment 33

 3.6. Payload Separation 33

 3.7. Collision/Contamination Avoidance Maneuver 34

4. PAYLOAD ENVIRONMENT 35

 4.1. Steady State and Transient Acceleration Loads 35

 4.1.1. Transient Loads 35

 4.1.2. Steady-State Acceleration 37

 4.2. Payload Vibration Environment 37

 4.2.1. Random Vibration 38

 4.2.2. Sine Vibration 38

4.3.	Payload Acoustic Environment	40
4.4.	Payload Shock Environment.....	41
4.5.	Payload Structural Integrity and Environments Verification.....	43
4.6.	Thermal and Humidity Environments.....	43
4.6.1.	Ground Operations	43
4.6.2.	Powered Flight.....	44
4.6.3.	Nitrogen Purge (Non-Standard Service)	45
4.7.	Payload Contamination Control	45
4.8.	Payload Electromagnetic Environment.....	46
5.	PAYLOAD INTERFACES.....	47
5.1.	Payload Fairing	47
5.1.1.	92" Standard Minotaur Fairing.....	47
5.1.1.1.	92" Fairing Payload Dynamic Design Envelope.....	47
5.1.2.	Optional 110" Fairing	48
5.1.2.1.	110" Fairing Payload Dynamic Design Envelope.....	48
5.1.3.	Payload Access Door	48
5.2.	Payload Mechanical Interface and Separation System	49
5.2.1.	Minotaur Coordinate System	49
5.2.2.	NGIS-Supplied Mechanical Interface Control Drawing	51
5.2.3.	Standard Non-Separating Mechanical Interface	51
5.2.4.	Optional Mechanical Interfaces	51
5.2.4.1.	Payload Cone Interfaces	53
5.2.4.2.	Dual and Multi Payload Adapter Fittings	53
5.2.4.2.1.	Dual-Payload Adapter Fitting	53
5.2.4.2.2.	Multi-Payload Adapter Fitting (MPAF)	55
5.2.4.2.3.	Minotaur V and VI+ Payload Adapter Fitting.....	56
5.2.5.	Optional Separation Systems.....	57
5.2.5.1.	NGIS 38" Separation System.....	59
5.2.5.2.	Planetary Systems Motorized Lightband (MLB).....	60
5.2.5.3.	RUAG 937 Separation Systems.....	60
5.3.	Payload Electrical Interfaces.....	61
5.3.1.	Payload Umbilical Interfaces	61
5.3.2.	Payload Interface Circuitry	62
5.3.3.	Payload Battery Charging.....	62
5.3.4.	Payload Command and Control	62
5.3.5.	Pyrotechnic Initiation Signals.....	62
5.3.6.	Payload Telemetry.....	63
5.3.7.	Payload Separation Monitor Loopbacks.....	63
5.3.8.	Telemetry Interfaces.....	63
5.3.9.	Non-Standard Electrical Interfaces.....	63
5.3.10.	Electrical Launch Support Equipment	63
5.4.	Payload Design Constraints.....	64
5.4.1.	Payload Center of Mass Constraints	64
5.4.2.	Final Mass Properties Accuracy.....	64

5.4.3.	Pre-Launch Electrical Constraints	64
5.4.4.	Payload EMI/EMC Constraints	64
5.4.5.	Payload Dynamic Frequencies.....	64
5.4.6.	Payload Propellant Slosh	65
5.4.7.	Payload-Supplied Separation Systems	65
5.4.8.	System Safety Constraints	65
6.	MISSION INTEGRATION.....	67
6.1.	Mission Management Approach	67
6.1.1.	SMC/ADSL Mission Responsibilities	67
6.1.2.	NGIS Mission Responsibilities.....	67
6.2.	Mission Planning and Development	68
6.2.1.	Mission Assurance	70
6.3.	Mission Integration Process.....	71
6.3.1.	Integration Meetings	71
6.3.2.	Mission Design Reviews (MDR)	71
6.3.3.	Readiness Reviews	71
6.4.	Documentation	72
6.4.1.	Customer-Provided Documentation	72
6.4.1.1.	Payload Questionnaire	72
6.4.1.2.	ICD Inputs	72
6.4.1.3.	Payload Mass Properties	72
6.4.1.4.	Payload Finite Element Model	72
6.4.1.5.	Payload Thermal Model for Integrated Thermal Analysis	73
6.4.1.6.	Payload Drawings	73
6.4.1.7.	Program Requirements Document (PRD) Mission Specific Annex Inputs	73
6.4.1.7.1.	Launch Operations Requirements (OR) Inputs	73
6.4.1.8.	Payload Launch Site Integration Procedures.....	73
6.4.1.9.	ICD Verification Documentation	73
6.4.2.	NGIS-Produced Documentation, Data, and Analyses	74
6.4.2.1.	Launch Vehicle to Payload ICD	74
6.4.2.2.	ICD Verification Documentation	74
6.4.2.3.	Preliminary Mission Analyses	74
6.4.2.4.	Coupled Loads Analyses (CLA)	74
6.4.2.5.	Integrated Launch Site Procedures.....	74
6.4.2.6.	Missile System Pre-Launch Safety Package (MSPSP) Annex.....	75
6.4.2.7.	PRD Mission Specific Annex.....	75
6.4.2.8.	Launch Operation Requirements (OR)	75
6.4.2.9.	Mission Constraints Document (MCD).....	75
6.4.2.10.	Final Countdown Procedure.....	75
6.4.2.11.	Post-Launch Analyses.....	75
6.5.	Safety	76
6.5.1.	System Safety Requirements	76
6.5.2.	System Safety Documentation	76
7.	GROUND AND LAUNCH OPERATIONS	77

7.1.	Launch Vehicle Integration Overview	78
7.1.1.	Planning and Documentation	78
7.1.2.	Guidance and Control Assembly Integration and Test Activities	78
7.1.3.	PK Motor Integration and Test Activities	79
7.1.4.	Mission Simulation Tests.....	79
7.1.5.	Launch Vehicle Processing Facilities	79
7.2.	Payload Processing/Integration	79
7.2.1.	Payload Propellant Loading.....	80
7.3.	Launch Operations.....	80
7.3.1.	Booster Assembly Stacking/Launch Site Preparation	81
7.3.2.	Final Vehicle Integration and Test.....	81
7.3.3.	Launch Vehicle Arming.....	81
7.3.4.	Launch	82
7.3.5.	Launch Control Organization.....	83
7.3.6.	Launch Rehearsals.....	83
8.	OPTIONAL ENHANCED CAPABILITIES.....	85
8.1.	Separation System and Optional Mechanical Interfaces	85
8.2.	Conditioned Air	85
8.3.	Nitrogen Purge	85
8.4.	Additional Access Panel	85
8.5.	Enhanced Telemetry.....	86
8.6.	Enhanced Contamination Control.....	86
8.6.1.	Low Outgassing Materials	86
8.6.2.	High Cleanliness Integration Environment	87
8.6.3.	HEPA-Filtered Fairing Air Supply	87
8.6.4.	Fairing Surface Cleanliness.....	87
8.7.	Secure FTS.....	87
8.8.	Over Horizon Telemetry.....	88
8.9.	Increased Insertion Accuracy.....	89
8.10.	Payload Isolation System.....	90
8.11.	Orbital Debris Mitigation.....	90
8.12.	Dual and Multi Payload Adapter Fittings.....	91
8.13.	Enhanced Performance	91
8.14.	Large Fairing	91
8.15.	Hydrazine Servicing	91
8.16.	Nitrogen Tetroxide Service	92
8.17.	Poly-Pico Orbital Deployer (P-POD).....	92
8.18.	Suborbital Performance	93
8.19.	Alternate Launch Locations	95

LIST OF FIGURES

Figure 1.1-1. The Minotaur Family of Launch Vehicles 2

Figure 1.1-2. Space Launch Performance for the Minotaur Family Demonstrates a Wide Range of Payload Lift Capability 3

Figure 2.1-1. Minotaur IV Baseline Launch Vehicle..... 5

Figure 2.3-1. Minotaur IV Expanded View Showing NGIS' State-of-the-Art Structures and Modular Architecture 7

Figure 2.3.1-1. GFE Peacekeeper Stages 1, 2, and 3 Have an Extensive Flight History with over 50 Launches 7

Figure 2.3.3-1. The Adaptable and Flexible Design of Minotaur Affords a Wide Range of Options for Payload Customers 8

Figure 2.3.2-1. Orion 38 Stage 4 Motor 8

Figure 2.3.5-1. Minotaur IV 92" Fairing and Handling Fixtures..... 11

Figure 2.3.6.1-1. Minotaur IV+ Enhancement..... 12

Figure 2.3.6.2-1. Minotaur V Vehicle Configuration 13

Figure 2.3.6.3-1. Minotaur VI Vehicle Configuration 14

Figure 2.3.6.4-1. Minotaur VI+ Vehicle Configuration..... 15

Figure 2.4-1. Multiple Sets of MGSE Are Available to Support Parallel Missions 16

Figure 2.4-2. Functional Block Diagram of LSE..... 17

Figure 3.1-1. Generic Minotaur IV Mission Profile 19

Figure 3.2-1. Flexible Processing and Portable GSE Allows Operations from Multiple Ranges or Austere Site Options 20

Figure 3.2-2. Launch Site Inclinations..... 20

Figure 3.3-1. Minotaur IV Fleet Comparison Performance Curves for SSO Out of KLC..... 23

Figure 3.3-2. Minotaur IV Fleet Comparison Performance Curves for 28.5° Inclination Orbits Out of CCAFS 23

Figure 3.3.1-1. Minotaur IV Performance Curves for VAFB Launches..... 24

Figure 3.3.1-2. Minotaur IV Performance Curves for KLC Launches 24

Figure 3.3.1-3. Minotaur IV Performance Curves for CCAFS Launches..... 25

Figure 3.3.1-4. Minotaur IV Performance Curves for WFF Launches 25

Figure 3.3.2-1. Minotaur IV+ Performance Curves for VAFB Launches..... 26

Figure 3.3.2-2. Minotaur IV+ Performance Curves for KLC Launches 26

Figure 3.3.2-3. Minotaur IV+ Performance Curves for CCAFS Launches..... 27

Figure 3.3.2-4. Minotaur IV+ Performance Curves for WFF Launches 27

Figure 3.3.3-1. Minotaur VI (92" Fairing) Performance Curves for CCAFS Launches 28

Figure 3.3.3-2. Minotaur VI (92" Fairing) Performance Curves for KLC Launches 28

Figure 3.3.3-3. Minotaur VI (110" Fairing) Performance Curves for CCAFS Launches 29

Figure 3.3.3-4. Minotaur VI (110" Fairing) Performance Curves for KLC Launches 29

Figure 3.3.4-1. Minotaur IV+ Elliptical Orbits Performance Curve for KLC Launches..... 30

Figure 3.3.4-2. Minotaur V Elliptical Orbits Performance Curve for KLC Launches 30

Figure 3.3.4-3. Minotaur VI+ Elliptical Orbits Performance Curves for KLC Launches..... 31

Figure 3.3.4-4. Minotaur V/VI+ High Energy Orbit Performance Curves for CCAFS Launches..... 31

Figure 3.3.4-5. Minotaur V High Energy Orbit Performance Curve for WFF Launches 32

Figure 4.1.1-1. Payload CG Net Transient Lateral Acceleration (Minotaur IV)..... 36

Figure 4.1.1-2. Payload CG Net Transient Lateral Acceleration (Minotaur IV+, V, VI, and VI+) 36

Figure 4.1.2-1. Minotaur IV Family Maximum Axial Acceleration as a Function of Payload Mass..... 37

Figure 4.2.1-1. Minotaur IV Family Payload Random Vibration Environment	38
Figure 4.2.2-1. Minotaur IV, IV+, and VI Payload Sine Vibration MPE Levels	39
Figure 4.2.2-2. Minotaur V and VI+ Payload Sine Vibration MPE Levels.....	39
Figure 4.3-1. Minotaur IV Payload Acoustic Maximum Predicted Environment (MPE) with 1/3 Octave Breakpoints.....	40
Figure 4.4-1. Minotaur IV Family Payload Shock Maximum Predicted Environment (MPE) – Launch Vehicle to Payload	41
Figure 4.4-2. Minotaur V/VI+ Payload Shock MPE – Launch Vehicle to Payload.....	42
Figure 4.4-3. Maximum Shock Environment - Payload to Launch Vehicle.....	42
Figure 4.6.1-1. Minotaur IV HVAC System Provides Conditioned Air to the Payload	44
Figure 5.1.1.1-1. Dynamic Envelope for Standard 92” Fairing with Standard 38” PAF	47
Figure 5.1.2.1-1. Dynamic Envelope for Optional 110” Fairing with Standard 38” PAF	48
Figure 5.1.3-1. Available Fairing Access Door Locations	49
Figure 5.2.1-1. Minotaur IV Coordinate System.....	50
Figure 5.2.3-1. Standard, Non-separating 38.81” Diameter Payload Mechanical Interface.....	51
Figure 5.2.4.1-1. Dynamic Envelope for Standard 92” Fairing with Optional 38” 2-Piece Payload Cone	53
Figure 5.2.4.1-2. Dynamic Envelope for Standard 92” Fairing with Optional 62” Payload Cone	53
Figure 5.2.4.1-3. Dynamic Envelope for Optional 110” Fairing with Optional 62” Payload Cone.....	54
Figure 5.2.4.2.1-1. Dynamic Envelope for Standard 92” Fairing with Optional DPAF.....	54
Figure 5.2.4.2.2-1. Dynamic Envelope for Standard 92” Fairing with Optional MPAF	55
Figure 5.2.4.2.2-2. Optional Multi-Payload Adapter Plate (MPAP) Non-Separating Mechanical Interface – Accommodates 2 to 4 ESPA-Class Payloads.....	55
Figure 5.2.4.2.3-1. Dynamic Envelope for Standard 92” Fairing and Minotaur V / VI+ Enhanced Performance Option	56
Figure 5.2.4.2.3-2. Dynamic Envelope for Standard 92” Fairing and Minotaur V / VI+ Enhanced Performance Option with Optional PAF	56
Figure 5.2.4.2.3-3. Minotaur V PAF Non-Separating Mechanical Interface	57
Figure 5.2.5.1-1. NGIS 38” Separation System	59
Figure 5.2.5.2-1. 38” Planetary Sciences Motorized Lightband.....	60
Figure 5.2.5.3-1. RUAG 937S 38” Separation System	60
Figure 5.3.1-1. Payload 1:1 Umbilical Pin Outs	61
Figure 5.3.2-1. Payload Electrical Interface Block Diagram	62
Figure 6.1-1. Mission Integration Team	67
Figure 6.2-1. Typical Mission Integration Schedule.....	69
Figure 6.2-2. Typical Mission Field Integration Schedule	70
Figure 7-1. Hardware Flow – Factory to Launch Site	77
Figure 7.1-1. Launch Vehicle Processing Flow at the MPF.....	78
Figure 7.1-2. Minotaur Launch Vehicle Integration at MPF	78
Figure 7.1.5-1. Minotaur Processing Is Performed at the MPF at VAFB.....	79
Figure 7.2-1. Payload Processing and LV Integration Flow at the PPF	80
Figure 7.2-2. Payload Encapsulation at the PPF	80
Figure 7.2-3. Encapsulated Payload Transport to the Launch Site	80
Figure 7.3-1. Minotaur IV Launch Site Operations	81
Figure 7.3.1-1. Minotaur Uses Vertical Integration for Each Booster Stage, the Guidance Control Assembly, and the Encapsulated Payload Assembly.....	82

Figure 7.3.4-1. Notional Minotaur Countdown Timeline 82

Figure 7.3.4-2. Minotaur IV Prepared for Launch 83

Figure 8.3-1. GN₂ Purge Interface To Minotaur Fairing (Flyaway at Liftoff) 85

Figure 8.4-1. Example Location and Size of Additional Access Panel 85

Figure 8.5-1. Representative Minotaur 92” Enhanced Instrumentation Locations (Fairing Only) 86

Figure 8.6-1. Minotaur Team Has Extensive Experience in a Payload Processing Clean Room Environment 87

Figure 8.7-1. NGIS’ Secure FTS System Block Diagram 88

Figure 8.8-1. TDRSS 20W LCT2 Transmitter and Cavity Backed S-band Antenna..... 88

Figure 8.8-2. TDRSS Notional Telemetry Flow..... 89

Figure 8.9-1. Hydrazine Auxiliary Propulsion System (HAPS) Used to Provide Insertion Accuracy 89

Figure 8.10-1. Minotaur Soft Ride Significantly Attenuates Peak LV Dynamic Environments 90

Figure 8.11-1. Operational and Disposal LEOs 90

Figure 8.15-1. Typical Propellant Loading Schematic 91

Figure 8.15-2. UPC Provides Reliable and Demonstrated Hydrazine Servicing for Minotaur..... 92

Figure 8.17-1. P-PODs Have Successfully Flown On Multiple Minotaur Missions..... 93

Figure 8.18-1. Expanded View of Minotaur IV Lite Configuration..... 94

Figure 8.19-1. Minotaur IV Vehicle Processing and Launch From KLC 95

Figure 8.19-2. Launch Complex 46 at CCAFS Supports All Minotaur Configurations 95

LIST OF TABLES

Table 3.2-1. Baseline Launch Sites for the Minotaur IV Family of Launch Vehicles 19

Table 3.3-1. Common Mission Options and Associated Masses (These Masses Must Be Subtracted from the LV Performance) 22

Table 3.3.4-1. Geosynchronous Transfer Orbit (GTO) Performance For CCAFS..... 32

Table 3.3.4-2. Medium Transfer Orbit (MTO) Performance For CCAFS..... 32

Table 3.3.4-3. Medium Transfer Orbit (MTO) Performance For WFF 33

Table 3.4-1. Minotaur IV Injection Accuracy 33

Table 3.5-1. Typical Pre-Separation Payload Pointing and Spin Rate Accuracies 33

Table 4.8-1. Minotaur IV Launch Vehicle RF Emitters and Receivers 46

Table 5.2.4-1. Minotaur IV Payload Adapter Fitting Options 52

Table 5.2.5-1. Minotaur IV Separation System Options 58

Table 5.4.2-1. Payload Mass Properties Measurement Tolerance..... 64

Table 8.9-1. Enhanced Insertion Accuracy 89

LIST OF APPENDICES

APPENDIX A. PAYLOAD QUESTIONNAIRE.....A-1

GLOSSARY

A-CAT 1	Acquisition Category	LEV	Launch Equipment Vault
A/D	Arm/Disarm	LOCC	Launch Operations Control Center
AAC	Alaska Aerospace Corporation	LRR	Launch Readiness Review
ACS	Attitude Control System	LSE	Launch Support Equipment
AFRL	Air Force Research Laboratory	LSV	Launch Support Van
ATM	Acceleration Transformation Matrix	LTM	Load Transformation Matrix
BCM	Booster Control Module	LV	Launch Vehicle
BER	Bit Error Rate	MA	Mission Assurance
C/CAM	Collision/Contamination Avoidance Maneuver	MACH	Modular Avionics Control Hardware
CBOD	Clamp Band Opening Device	MARS	Mid-Atlantic Regional Spaceport
CCAFS	Cape Canaveral Air Force Station	MCD	Mission Constraints Document
CDR	Critical Design Review	MDR	Mission Design Review
CG	Center-of-Gravity	MDR	Mission Dress Rehearsal
CLA	Coupled Loads Analysis	MGSE	Mechanical Ground Support Equipment
CLF	Commercial Launch Facility	MICD	Mechanical Interface Control Drawing
CRD	Command Receiver Decoder	MIWGs	Mission Integration Working Groups
CVCM	Collected Volatile Condensable Mass	MLB	Motorized Lightband
DIACAP	DoD Information Assurance Certification and Accreditation Process	MPAF	Multi-Payload Adapter Fitting
DPAF	Dual Payload Adapter Fitting	MPAP	Multi-Payload Adapter Plate
ECU	Environmental Control Unit	MPE	Maximum Predicted Environment
EELV	Evolved Expendable Launch Vehicle	MPF	Minotaur Processing Facility
EGSE	Electrical Ground Support Equipment	MRD	Mission Requirements Document
EME	Electromagnetic Environment	MRR	Mission Readiness Review
EMI	Electromagnetic Interference	MSPSP	Missile System Pre-Launch Safety Package
ESPA	EELV Secondary Payload Adapter	MST	Mission Simulation Test
FAA	Federal Aviation Administration	MTO	Medium Transfer Orbit
FRR	Flight Readiness Review	NGIS	Northrop Grumman Innovation Systems
FTS	Flight Termination System	NTO	Nitrogen Tetroxide
GCA	Guidance and Control Assembly	OD	Operations Directive
GFE	Government Furnished Equipment	ODM	Ordnance Driver Module
GN ₂	Gaseous Nitrogen	OML	Outer Mold Line
GPB	GPS Positioning Beacon	OR	Operations Requirements
GPS	Global Positioning System	NGIS	NGIS, Inc.
GTO	Geosynchronous Transfer Orbit	OSP-3	Orbital Suborbital Program 3
HAPS	Hydrazine Auxiliary Propulsion System	P-POD	Poly-Pico Orbital Deployer
HVAC	Heating, Ventilation and Air Conditioning	PAF	Payload Attach Fitting
ICD	Interface Control Document	PAM	Payload Adapter Module
INS	Inertial Navigation System	PCM	Pulse Code Modulation
IRR	Incremental Readiness Review	PDR	Preliminary Design Review
IRRT	Independent Readiness Review Team	PEM	Program Engineering Manager
KLC	Kodiak Launch Complex	PPF	Payload Processing Facility
LAN	Longitude of Ascending Node	PRD	Program Requirements Document
LC-46	Launch Complex 46	PSP	Program Support Plan
LCR	Launch Control Room	PSRR	Pre-Ship Readiness Review
LEO	Low Earth Orbit	RAAN	Right Ascension of Ascending Node
		RF	Radio Frequency

RTS	Range Tracking System
RWG	Range Working Group
SCAPE	Self-Contained Atmospheric Protective Ensemble
SEB	Support Equipment Building
SLC-8	Space Launch Complex 8
SMC/AD	US Air Force, Space and Missile Systems Center, Advanced Systems and Development Directorate
SMC/ADSL	US Air Force, Space and Missile Systems Center, Advanced Systems and Development Directorate, Rocket Systems Launch Program
SRSS	Softride for Small Satellites
SSI	Spaceport Systems International
START	Strategic Arms Reduction Treaty
TDRSS	Telemetry Data Relay Satellite System
TLI	Trans-Lunar Injection
TML	Total Mass Loss
TVA	Thrust Vector Actuator
TVC	Thrust Vector Control
UPC	United Paradyne Corporation
VAFB	Vandenberg Air Force Base
WFF	Wallops Flight Facility
WPs	Work Packages

1. INTRODUCTION

This User's Guide is intended to familiarize payload mission planners with the capabilities of the Orbital Suborbital Program 3 (OSP-3) Minotaur IV Launch Vehicle (LV) launch service. The information provided in this user's guide is for initial planning purposes only. Information for development/design is determined through mission specific engineering analyses. The results of these analyses are documented in a mission-specific Interface Control Document (ICD) for the payload organization to use in their development/design process. This User's Guide provides an overview of the Minotaur IV family of launch vehicles system design and a description of the services provided to our customers. The Minotaur IV family of launch vehicles includes the Minotaur IV, IV+, V, VI, and VI+. Minotaur vehicles offer a variety of enhancement options to allow the maximum flexibility in satisfying the objectives of single or multiple payloads.

The primary mission of the Minotaur IV family of vehicles is to provide low cost, high reliability launch services to government-sponsored payloads. The Minotaur design accomplishes this using flight proven components with significant flight heritage. The philosophy of placing mission success as the highest priority is reflected in the success and accuracy of all Minotaur missions to date.

This User's Guide describes the basic elements of the Minotaur IV system as well as optional services that are available. In addition, this document provides general vehicle performance, defines payload accommodations and environments, and outlines the Minotaur mission integration process. Minotaur-unique integration and test approaches (including the typical operational timeline for payload integration with the Minotaur vehicles) and the ground support equipment that will be used to conduct Minotaur operations are also described.



1.1. Minotaur Family Performance and Capability

Figure 1.1-1 shows the Minotaur family of launch vehicles, which is capable of launching a wide range of payload sizes and missions. Representative space launch performance across the Minotaur fleet is shown in Figure 1.1-2 and illustrates the relative capability of each configuration. In addition to space launch capabilities, the Minotaur I Lite and Minotaur IV Lite configurations are available to meet suborbital payload needs for payloads weighing up to 3000 kg. This User's Guide covers the Peacekeeper-based Minotaur IV family. Please refer to the Minotaur I User's Guide for information regarding Minuteman-based Minotaur vehicles.

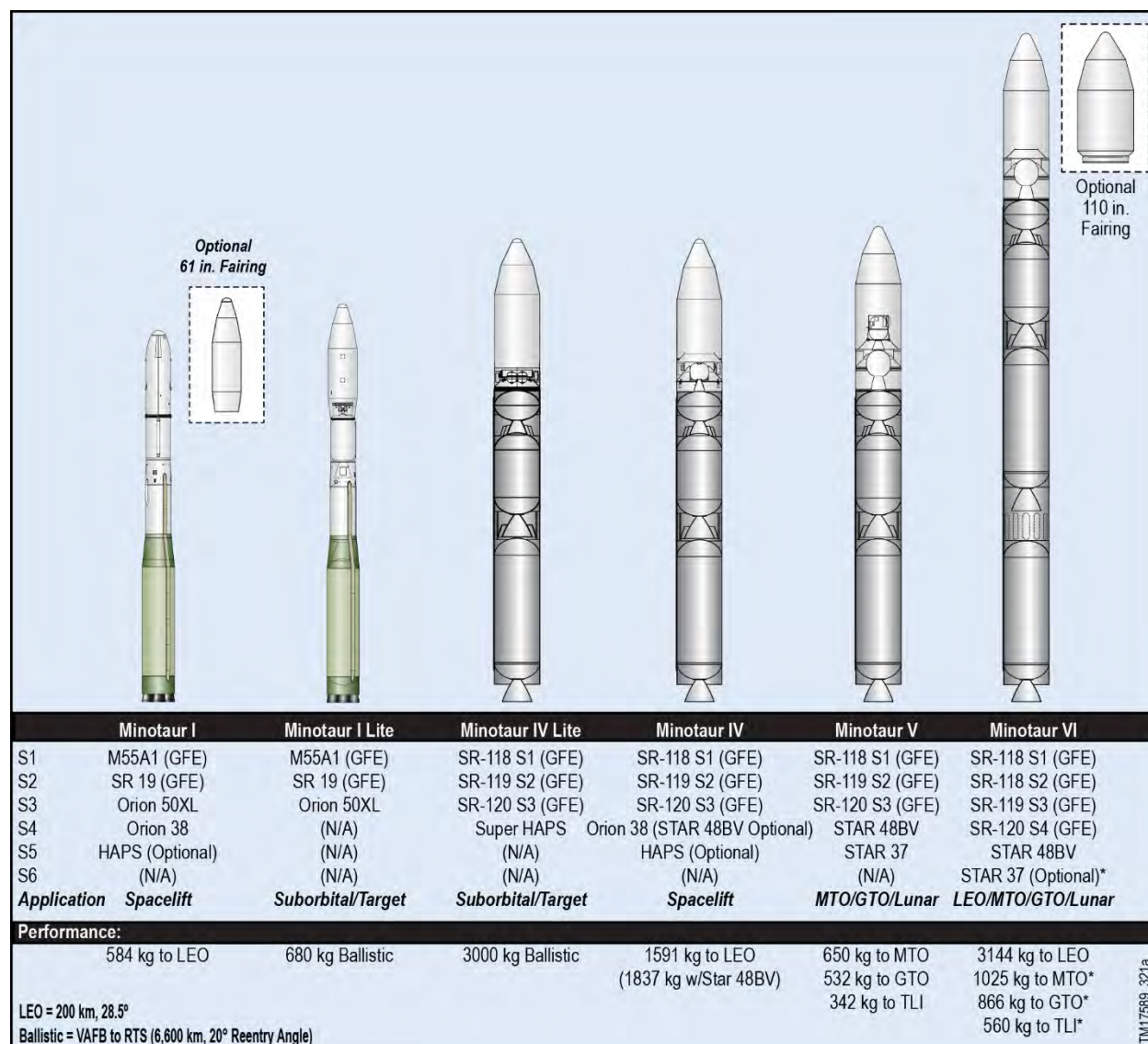

Figure 1.1-1. The Minotaur Family of Launch Vehicles

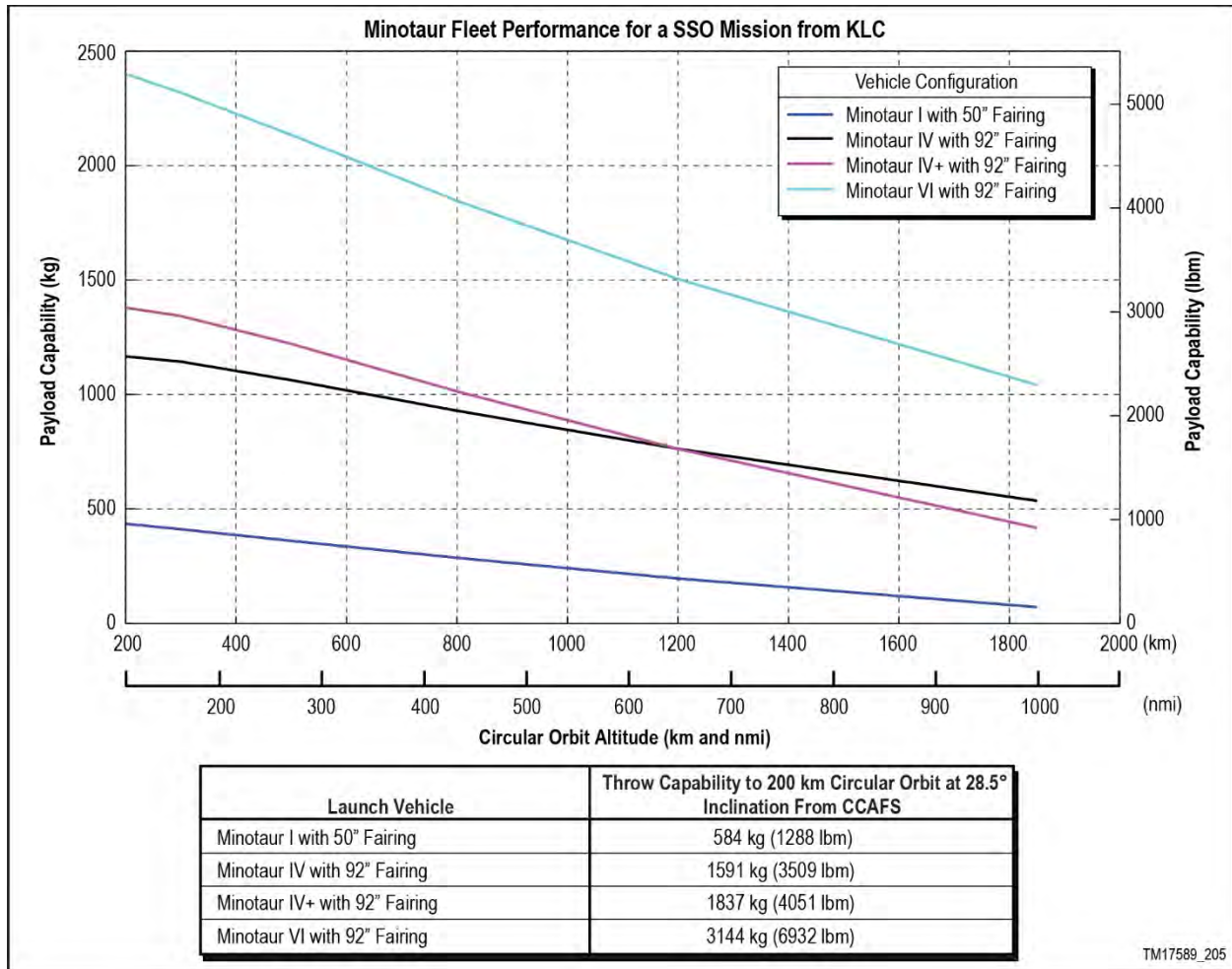

Figure 1.1-2. Space Launch Performance for the Minotaur Family Demonstrates a Wide Range of Payload Lift Capability

This page left intentionally blank.

2. MINOTAUR IV CONFIGURATIONS

2.1. Minotaur IV Launch System Overview

The Minotaur IV (Figure 2.1-1) mission is to provide a cost effective, reliable and flexible means of placing satellites into orbit. Northrop Grumman Innovation Systems (NGIS) is the launch vehicle provider and manufacturer under the Orbital Suborbital Program 3 (OSP-3) contract for the U.S. Air Force. An overview of the system and available launch services is provided within this section, with specific elements covered in greater detail in the subsequent sections of this User's Guide.

The Minotaur IV family of launch vehicles has been designed to meet the needs of U.S. Government-sponsored customers at a lower cost than commercially available alternatives by using surplus Peacekeeper boosters. As stated previously, the Minotaur IV family of launch vehicles includes the Minotaur IV, IV+, V, VI, and VI+. The requirements of the OSP-3 program emphasize system reliability, transportability, and operation from multiple launch sites. Minotaur IV draws on the successful heritage of NGIS' space launch vehicles as well as the USAF Peacekeeper system to meet these requirements. NGIS has built upon these legacy systems with enhanced avionics components and advanced composite structures to meet the payload-support requirements of the OSP-3 program. Combining these subsystems with the long successful history of the Peacekeeper boosters has resulted in a simple, robust, self-contained launch system to support government-sponsored small satellite launches.

The Minotaur IV system also includes a complete set of transportable Launch Support Equipment (LSE) designed to allow Minotaur IV to be operated as a self-contained satellite delivery system. To accomplish this goal, the Electrical Ground Support Equipment (EGSE) has been developed to be portable and adaptable to varying levels of infrastructure. While the Minotaur IV system is capable of self-contained operation at austere launch sites using portable vans, typical operations occur from permanent facilities on established ranges.

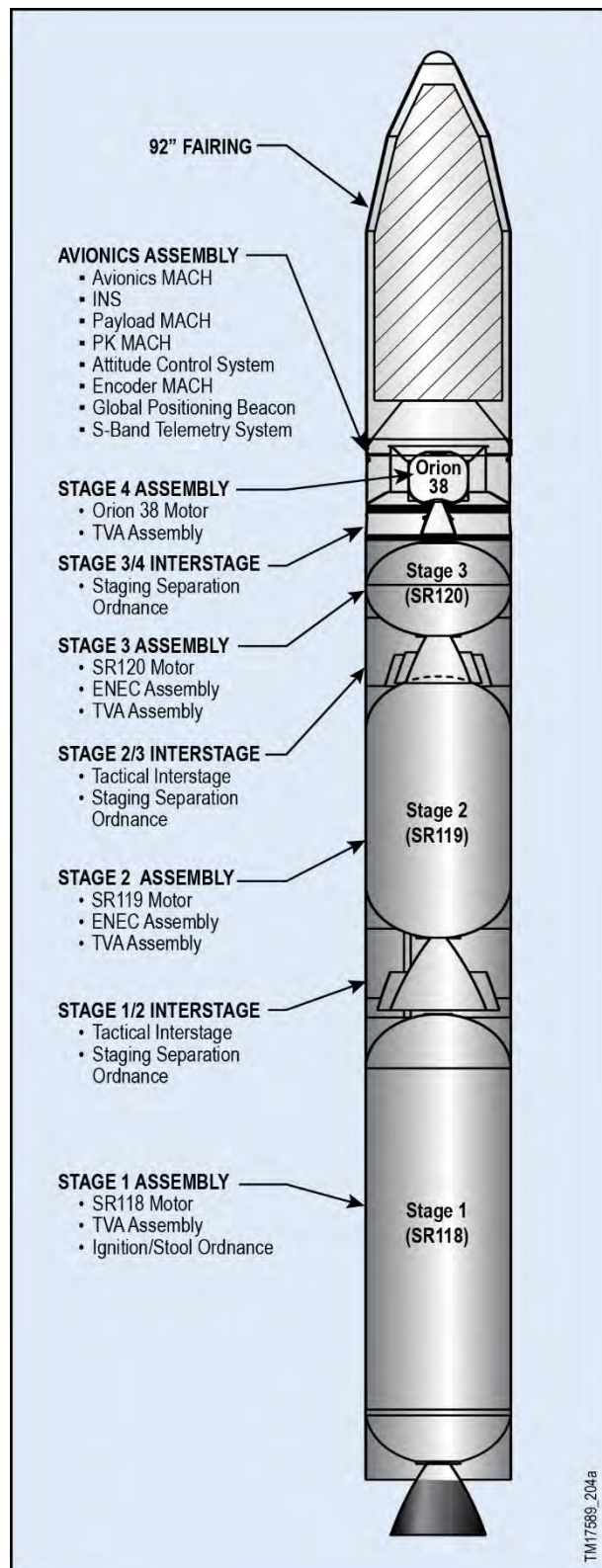

Figure 2.1-1. Minotaur IV Baseline Launch Vehicle

The Minotaur IV system is designed to be capable of launch from four commercial Spaceports (Alaska, California, Florida, and Mid-Atlantic), as well as from existing U.S. Government facilities at VAFB and CCAFS. A Launch Control Room (LCR) serves as the control center for conducting a Minotaur IV launch and includes consoles for NGIS, range safety, and limited customer personnel. Further description of the Launch Support Equipment is provided in Section 2.4.

2.2. Minotaur IV Launch Service

The Minotaur IV Launch Service is provided through the combined efforts of the USAF and NGIS, along with associate contractors and commercial spaceports. The primary customer interface will be with the USAF Space and Missile Systems Center, Advanced Systems and Development Directorate (SMC/AD), Rocket Systems Launch Program (SMC/ADSL). NGIS is the launch vehicle provider. This integrated team will be referred to collectively as "OSP" throughout the User's Guide. Where necessary, interfaces that are associated with a particular member of the team will be referred to directly (i.e., NGIS or ADSL).

OSP provides all of the necessary hardware, software and services to integrate, test, and launch a payload into its prescribed orbit. In addition, OSP will complete all the required agreements, licenses and documentation to successfully conduct Minotaur IV operations. The Minotaur IV mission integration process completely identifies, documents, and verifies all spacecraft and mission requirements.

2.3. Minotaur IV Launch Vehicle

The Minotaur IV baseline vehicle, shown in expanded view in Figure 2.3-1, is a four-stage, inertially guided, all solid propellant ground launched vehicle. Conservative design margins, state-of-the-art structural systems, a modular avionics architecture and simplified integration and test capability yield a robust, highly reliable launch vehicle design. In addition, Minotaur IV payload accommodations and interfaces are designed to satisfy a wide range of potential payload requirements.

2.3.1. Stage 1, 2 and 3 Booster Assemblies

The first three stages of the Minotaur IV consist of the refurbished Government Furnished Equipment (GFE) Peacekeeper Stages 1, 2, and 3, shown in Figure 2.3.1-1. These booster assemblies are used as provided by the Government, requiring no modification. They have extensive flight history, with over 50 launches. All three stages are solid-propellant motors and utilize a movable nozzle controlled by a Thrust Vector Actuator (TVA) system for three-axis attitude control. The first stage provides 500,000 lbf (2224 kN) of thrust. The second stage motor has an extendable exit cone and provides an average thrust of 275,000 lbf (1223 kN). The third stage provides 65,000 lbf (289 kN) of thrust and also features an extendable exit cone similar to Stage 2.

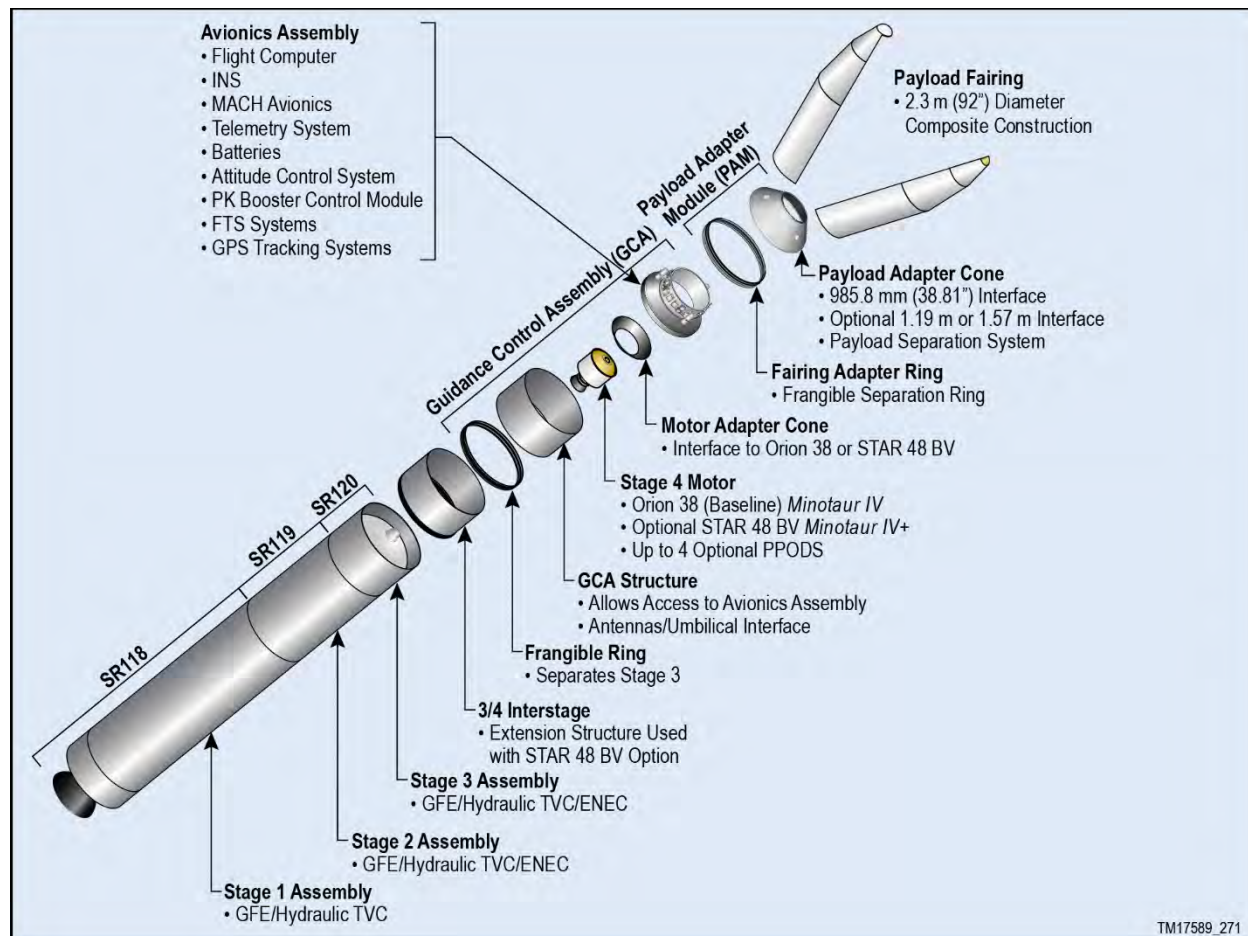

Figure 2.3-1. Minotaur IV Expanded View Showing NGIS' State-of-the-Art Structures and Modular Architecture

2.3.2. Upper Stage Propulsion

The Minotaur IV baseline Stage 4 motor is the Orion 38 (Figures 2.3.2-1). This motor was originally developed for NGIS' Pegasus program and is used on many other NGIS launch vehicles, including Minotaur I. The Orion 38 motor provides the velocity needed for orbit insertion for the launch vehicle, in the same manner as it is used on the Minotaur I. This motor features state-of-the-art design and materials with a successful flight heritage. It is currently in production and is actively flying payloads into space, with over 60 launches.

While the baseline Minotaur IV 4th Stage is the Orion 38, the flexible Minotaur IV design allows for a number of performance enhancements such as replacing the Orion 38 with a STAR 48, adding a 5th stage STAR 37 motor, and adding a Hydrazine Auxiliary Propulsion System (HAPS) for precise targeting or orbital insertion requirements. These options are described in detail later in this section as well as in Section 8.0.



Figure 2.3.1-1. GFE Peacekeeper Stages 1, 2, and 3 Have an Extensive Flight History with over 50 Launches

2.3.3. Guidance and Control Assembly (GCA)

The Guidance and Control Assembly (GCA) is the heart of the launch vehicle, comprised of an Avionics Assembly as well as the GCA Skirt which forms the 92 inch Outer Mold Line (OML). The Avionics Assembly houses all of the required subsystems for vehicle operation including power, telemetry, RF, ordnance, pneumatic, and guidance and control. In addition, the annular ring design of the Avionics Assembly enables multiple upper stage motor options (Figure 2.3.3-1). The GCA skirt has four large doors for ease of access to components within the Avionics Assembly. Antennas and thruster ports are mounted to the GCA skirt to allow for clear and unimpeded operation during flight.



Figure 2.3.2-1. Orion 38 Stage 4 Motor

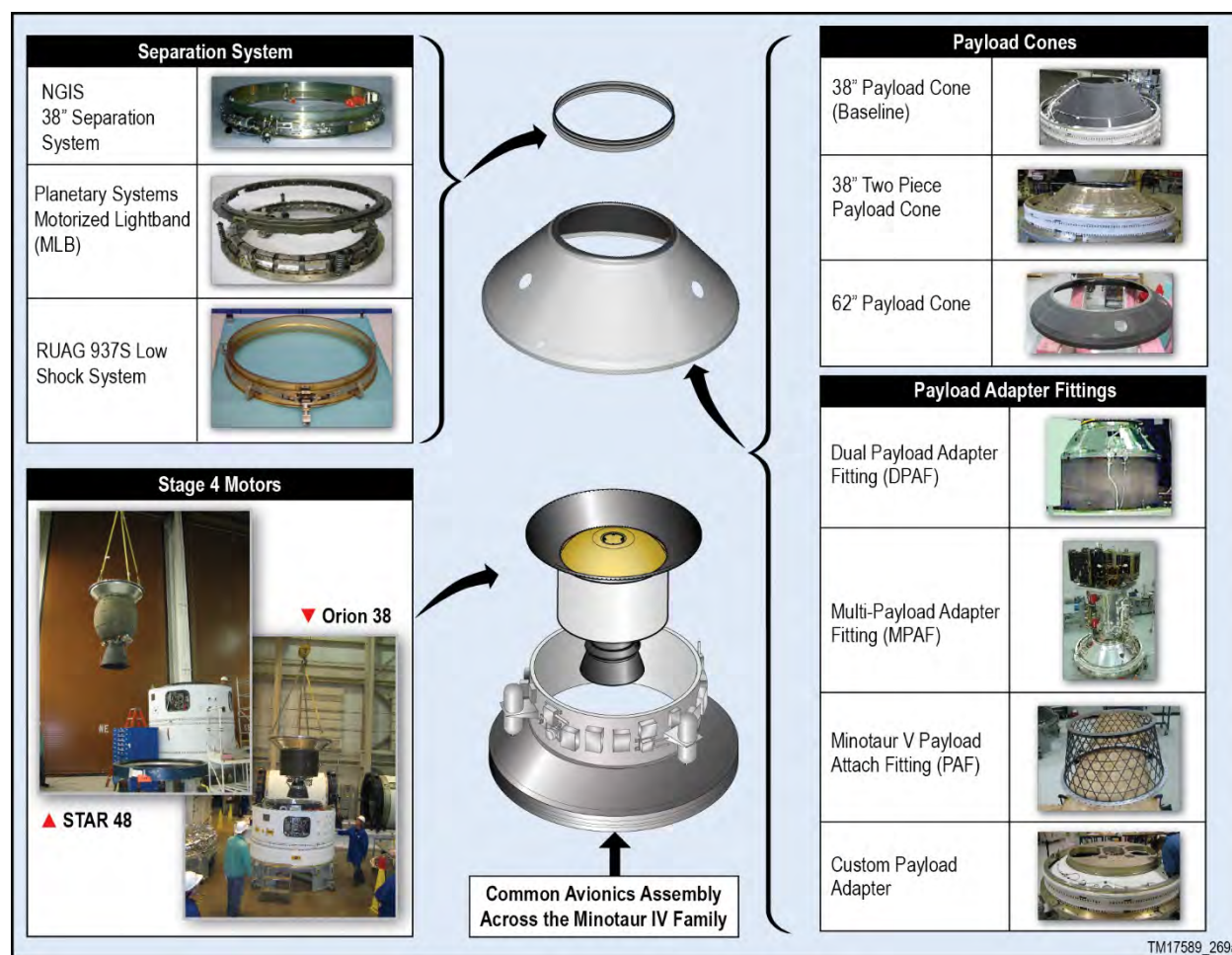

Figure 2.3.3-1. The Adaptable and Flexible Design of Minotaur Affords a Wide Range of Options for Payload Customers

2.3.3.1. Avionics

The Minotaur avionics system has heritage and commonality across the Minotaur fleet. The flight computer is a 32-bit multiprocessor architecture. It provides communication with vehicle subsystems, the Launch Support Equipment (LSE), and if required, the payload via standard RS-422 serial links and discrete I/O. The avionics system design incorporates NGIS' innovative, flight proven Modular Avionics Control Hardware (MACH). The MACH consists of standardized, function-specific modules that are combined in stacks of up to 10 modules to meet mission requirements. The functional modules from which the MACH stacks are created include power transfer, ordnance initiation, booster interface, communication, and telemetry processing. These modules provide an array of functional capability and flexibility in mission tailoring.

2.3.3.2. Attitude Control Systems

The Minotaur IV Control System provides attitude control throughout both boosted flight and coast phases. The NGIS-developed Booster Control Module (BCM) links the flight computer actuator commands to the individual Thrust Vector Actuators (TVAs) located on each PK motor. The available upper stage motors (Orion 38, STAR 48 and STAR 37) are commanded with the same Thrust Vector Control (TVC) control methodology as Minotaur I. This control combines a single-nozzle electromechanical TVC for pitch and yaw augmented with roll control from a three-axis, cold-gas Attitude Control System (ACS) resident within the GCA. The cold-gas ACS also provides 3-axis control as necessary during exoatmospheric coast and post-boost phases of flight.

Attitude control is achieved using a three-axis autopilot. Stages 1, 2 and 3 fly a pre-programmed attitude profile based on trajectory design and optimization. Stage 4 uses a set of pre-programmed orbital parameters to place the vehicle on a trajectory toward the intended insertion apse. An extended coast between Stages 3 and 4 is used to orient the vehicle to the appropriate attitude for Stage 4 ignition based upon a set of pre-programmed orbital parameters and the measured performance of the first three stages. Stage 4 utilizes energy management to place the vehicle into the proper orbit. After the final boost phase, the three-axis cold-gas attitude control system is used to orient the vehicle for spacecraft separation, contamination and collision avoidance and downrange downlink maneuvers. The autopilot design is modular, so additional payload requirements such as rate control or celestial pointing can be accommodated with minimal development effort.

2.3.3.3. Telemetry Subsystem

The Minotaur IV telemetry subsystem provides real-time health and status data of the vehicle avionics system, as well as key information regarding the position, performance and environment of the Minotaur IV vehicle. This data is used by both NGIS and the range safety personnel to evaluate system performance. The Minotaur IV baseline telemetry subsystem provides a number of dedicated payload discrete (bi-level) and analog telemetry monitors through dedicated channels in the launch vehicle encoder. The baseline telemetry system has a 1.5 Mbps data rate for both payload and Minotaur launch vehicle telemetry. To allow for flexibility in supporting evolving mission requirements, the output data rate can be selected over a wide range from 2.5 kbps to 10 Mbps (contingent on link margin and Bit Error Rate (BER) requirements). The telemetry subsystem nominally utilizes Pulse Code Modulation (PCM) with a RNRZ-L format. Other types of data formats, including NRZ-L, S, M, and Bi-phase may be implemented if required to accommodate launch range limitations. Furthermore, the launch vehicle telemetry system has the capability to take payload telemetry as an input, randomize if required, and downlink that dedicated payload link from launch through separation. That capability is available as a non-standard option.

The Enhanced Telemetry option as described in the Enhancements section 8.5 augments the existing baseline telemetry system by providing a dedicated telemetry link with a baseline data rate of 2 Mbps. This Enhanced Telemetry link is used to provide further insight into the mission environment due to additional payload, LV, or experiment data acquisition requirements. Supplementary instrumentation or signals such as strain gauges, temperature sensors, accelerometers, analog or digital data can be configured to meet payload mission-specific requirements.

An Over The Horizon Telemetry option can also be added to provide real-time telemetry coverage during ground-based telemetry receiving site blackout periods. The Telemetry Data Relay Satellite System (TDRSS) is used for this capability, and has been successfully demonstrated on past Minotaur missions. Close to the time when telemetry coverage is lost by ground based telemetry receiving sites, the LV switches telemetry output to the TDRSS antenna and points the antenna towards the designated satellite. The TDRSS then relays the telemetry to the ground where it is routed to the launch control room for real-time telemetry updates. Reference Enhancements section 8.8 for further details on this Over The Horizon Telemetry option.

Minotaur telemetry is subject to the provisions of the Strategic Arms Reduction Treaty (START). START treaty provisions require that certain Minotaur telemetry be unencrypted and provided to the START treaty office for dissemination to the signatories of the treaty.

2.3.4. Payload Interface

Forward of the GCA is the Payload Adapter Module (PAM), shown in Figure 2.3.4-1. It is comprised of the fairing frangible separation ring, fairing adapter ring and payload cone, which adapts from the 92 inch OML down to the standard 38 inch interface. This assembly provides both the mechanical interface with the payload as well as serves to close out the bottom of the encapsulated payload volume.

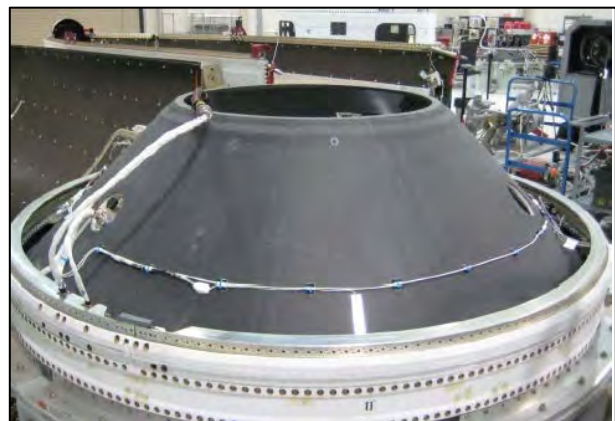

Figure 2.3.4-1. Minotaur IV Payload Adapter Module

Minotaur provides for a standard non-separating payload interface with the option of adding an NGIS-provided payload separation system. NGIS will provide all flight hardware and integration services necessary to attach non-separating and separating payloads to the Minotaur launch vehicle. Additional mechanical interface diameters and separation system configurations can readily be provided as an enhanced option as described in Section 5.0. Further detail on payload electrical, mechanical and launch support equipment interfaces can also be found in Section 5.0.

With the addition of various structural adapters, the Minotaur IV can accommodate multiple payloads. This feature, described in more detail in Section 5.2.4.2 of this User's Guide, permits two or more payloads to share the cost of a Minotaur IV launch, thus lowering the launch cost when compared to other launch options. Furthermore, NGIS can accommodate small payloads when there is excess payload and/or mass capability.

2.3.5. Payload Fairing

NGIS' flight proven Minotaur IV 92" diameter payload fairing (Figure 2.3.5-1) is used to encapsulate the payload, providing protection and contamination control during ground handling, integration operations and flight. The fairing is a bi-conic design made of graphite/epoxy face sheets with an aluminum honeycomb core. The fairing provides for low payload contamination through prudent design and selection of low contamination materials and processes. Acoustic blankets and internal conditioned air are standard service items that provide a more benign payload environment. Conditioned air will keep the payload environment to a specified temperature between 13 to 29 °C (55 to 85 °F) dependent upon requirements.

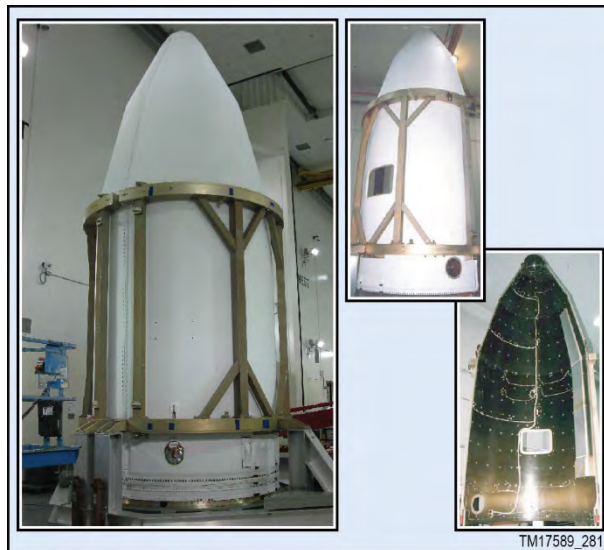

Figure 2.3.5-1. Minotaur IV 92" Fairing and Handling Fixtures

The two halves of the fairing are structurally joined along their longitudinal interface using NGIS' low contamination frangible joint system. An additional circumferential frangible joint at the base of the fairing supports the fairing loads. At separation, a cold-gas system is activated to pressurize the fairing deployment thrusters. The fairing halves then rotate about external hinges that control the fairing deployment to ensure that payload and launch vehicle clearances are maintained. All elements of the deployment system have been demonstrated through numerous ground tests and flights.

The Minotaur IV comes standard with a single payload access door; however, options for extra payload access doors and enhanced cleanliness are available. Further details on the baseline fairing are included in Section 5.1.

A larger 110" diameter fairing design is available as an enhancement (reference Section 5.1.2) to accommodate payloads larger than those that can be fit in the standard 92" diameter Minotaur IV fairing. The fairing, composite materials, structural testing, separation and deployment systems are similar to those of the heritage 92" fairing.

2.3.6. Minotaur IV Launch Vehicle Enhanced Performance Configurations

The modular design of the Minotaur IV vehicle allows for a substantial increase in performance with minimal vehicle changes. The Minotaur IV Enhanced Performance Configurations utilize the identical flight proven Peacekeeper stages, mechanical structures, avionics hardware, mechanical pneumatics, and ordnance subsystems as the base Minotaur IV vehicle.

The Minotaur IV Enhanced Performance Configurations are built to the same stringent requirements as the Minotaur IV vehicle and undergo an identical rigorous testing program.

2.3.6.1. Minotaur IV+ (STAR 48 Stage 4)

The flight proven Minotaur IV+ vehicle, shown in Figure 2.3.6.1-1, utilizes the larger STAR 48BV motor in place of the standard Stage 4 Orion 38 motor. Minotaur IV+ provides approximately 200 kg of increased performance to low-earth circular orbits and enables missions requiring highly elliptical orbits. The Minotaur IV+ vehicle is able to offer this increased performance without sacrificing available payload volume.

The adjustments necessary for the Minotaur IV+ only require the exchange of the standard Orion 38 composite Motor Adapter Cone for the STAR 48BV Motor Adapter Cone and the addition of a short extension structure to allow for the increased motor length.

The STAR 48BV provides an average burn time of 85.2 seconds at an average thrust of 68.63 kN (15.43 k-lbf). The total STAR 48BV mass is 2171 kg (4777 lbf), including a propellant mass of 2014 kg (4431 lbf).

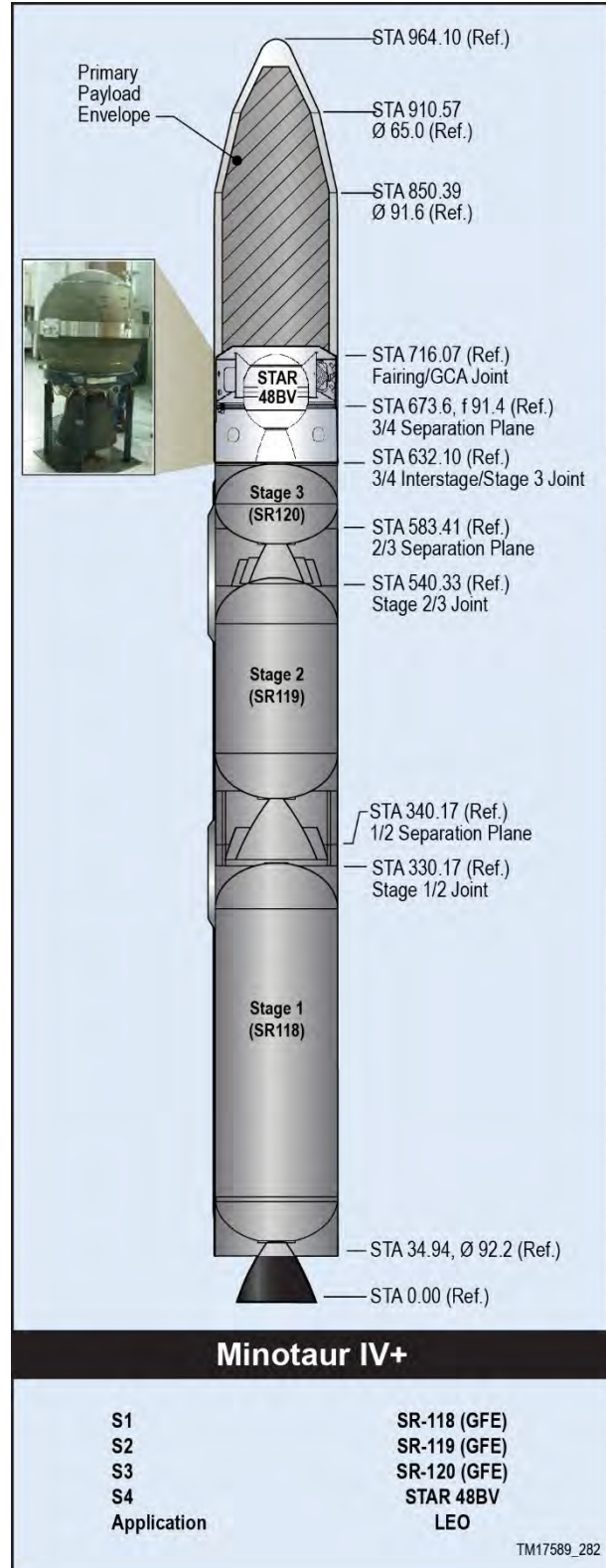

Figure 2.3.6.1-1. Minotaur IV+ Enhancement

2.3.6.2. Minotaur V (High Energy Performance)

The Minotaur V vehicle is a five stage evolutionary version of the Minotaur IV vehicle, shown in Figure 2.3.6.2-1, which provides a cost-effective capability to place small spacecraft into high energy trajectories, including Geosynchronous Transfer Orbit (GTO), Medium Transfer Orbit (MTO), as well as translunar injection. The Minotaur V vehicle leverages NGIS' flight proven heritage of the Minotaur IV and IV+ vehicles.

Minotaur V builds upon the Minotaur IV+ enhancement by incorporating a STAR 37 fifth stage within the fairing envelope. The design accommodates either spin-stabilized or 3-axis controlled versions of the STAR 37. The Minotaur V configuration represents a more than 25% increase in performance for highly elliptical orbits.

The STAR 37FM provides an average burn time of 62.5 seconds at an average thrust of 48.13 kN (10.82 k-lbf) and a total impulse of 3048 kN-sec (685.4 lbf-sec). The total STAR 37FM mass is 1150 kg (2531 lbm), including a propellant mass of 1068 kg (2350 lbm).

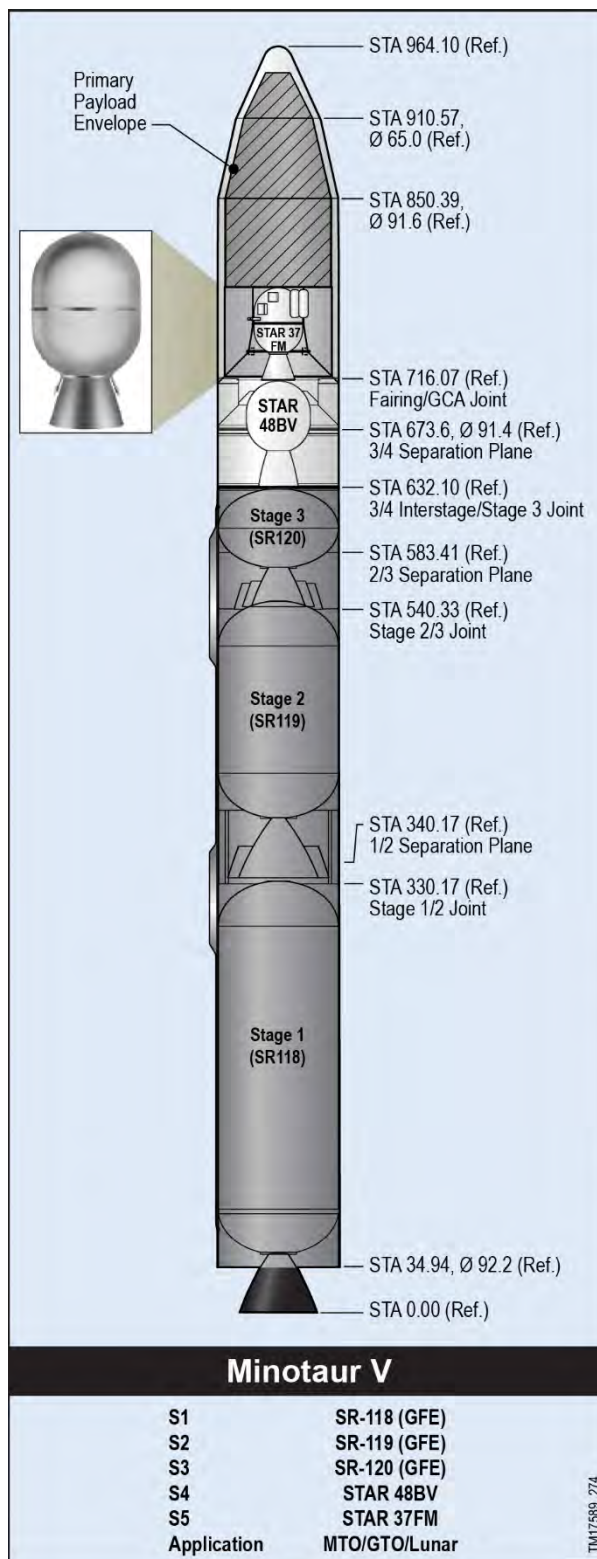

Figure 2.3.6.2-1. Minotaur V Vehicle Configuration

2.3.6.3. Minotaur VI

The Minotaur VI launch vehicle, shown in Figure 2.3.6.3-1, provides 1800-3200 kg (4000-7000 lbm) to Low Earth Orbit (LEO). Minotaur VI is a natural, low-risk evolution to the successful Minotaur IV vehicle family, adding an additional Peacekeeper Stage 1 (SR118) below the existing Minotaur IV+ stack (SR118-SR119-SR120-STAR 48BV). The new design elements of Minotaur VI are based on existing components, thereby minimizing risk.

Minotaur VI leverages heavily off the successful Minotaur IV+ vehicle, using the same front section assembly. All avionics, ordnance, and pneumatics components are already qualified for Minotaur VI environments. All mechanical structures have been designed and qualified to loads that encompass Minotaur VI with the exception of the payload interface cone. However, payload cone qualification is deemed low risk due to the safety margins predicted for Minotaur VI loads. Minotaur VI does not require new support equipment and only requires minor procedural changes to use existing Minotaur IV equipment and processes for integration and test activities.

Existing facilities and infrastructure at Kodiak Launch Complex (KLC) and Launch Complex 46 (LC-46) at CCAFS can accommodate Minotaur VI. The Minotaur VI launch system complies with range safety requirements RCC-319 and EWR 127-1, as tailored for Minotaur IV.

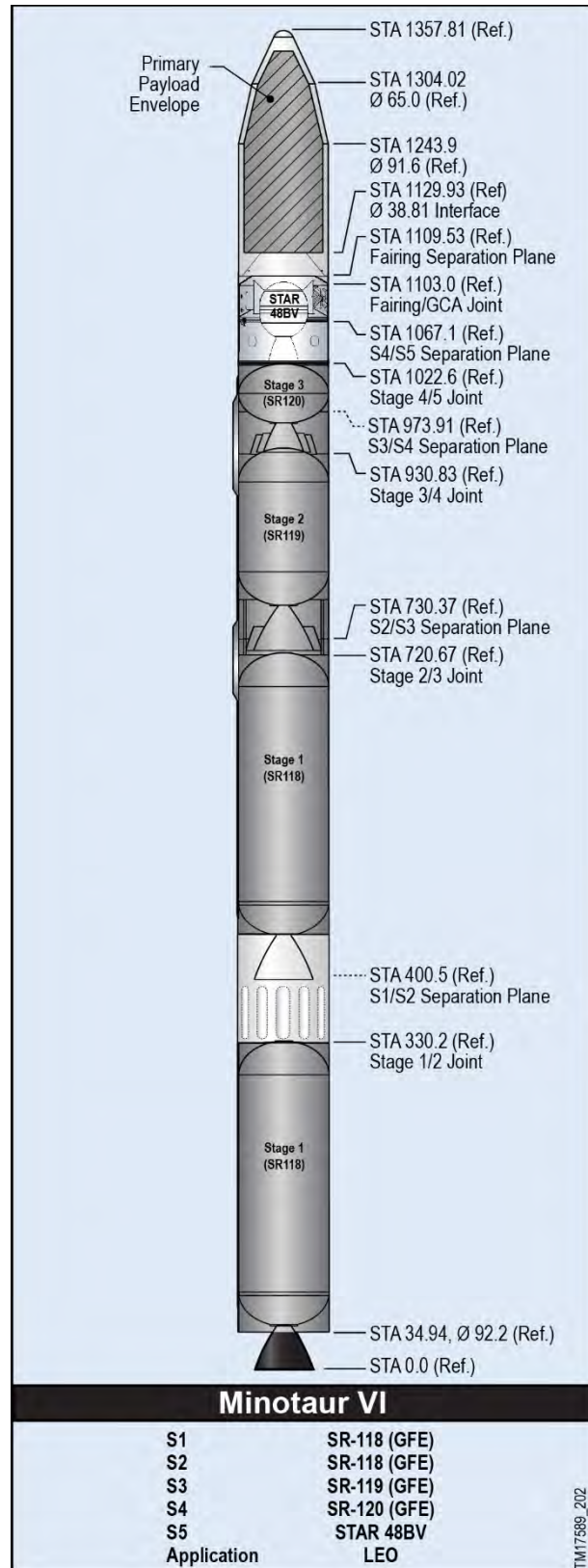

Figure 2.3.6.3-1. Minotaur VI Vehicle Configuration

2.3.6.4. Minotaur VI+ (High Energy Performance)

The Minotaur VI+ vehicle, shown in Figure 2.3.6.4-1, increases the Minotaur VI capability by adding a STAR 37FM as the final stage. Minotaur VI+ extends the Minotaur VI LEO capability to 3360 kg (7400 lbm). The Minotaur VI+ vehicle is also very capable for highly elliptical orbits or Earth escape trajectories such as a 300 kg (660 lbm) spacecraft on a trajectory to Mars.

Similar to Minotaur V, Minotaur VI+ adds a STAR 37 stage within the fairing envelope. The design accommodates either a spin-stabilized or 3-axis controlled version of the STAR 37.

Existing facilities and infrastructure at Kodiak Launch Complex (KLC) and LC-46 at CCAFS can accommodate Minotaur VI. The Minotaur VI launch system complies with range safety requirements RCC-319 and EWR 127-1, as tailored for Minotaur IV operations.

2.4. Launch Support Equipment

The Minotaur IV LSE is designed to be readily adaptable to varying launch site configurations with minimal unique infrastructure required. All of the Mechanical Ground Support Equipment (MGSE) used to support the Minotaur integration, test, and launch is currently in use and launch demonstrated, as shown in Figure 2.4-1. MGSE fully supports all Minotaur configurations and are routinely static load tested to safety factors in compliance with NGIS internal and Range requirements. The EGSE consists of readily transportable consoles that can be housed in various facility configurations depending on the launch site infrastructure. The EGSE is composed of three primary functional elements: Launch Control, Vehicle Interface, and Telemetry Data Reduction. The Launch Control and Telemetry Data Reduction consoles are located in the Launch Control Room (LCR), or mobile launch equipment van depending on available launch site accommodations. The Vehicle Interface consoles are located at the launch pad in a permanent structure, typically called a Launch Equipment Vault (LEV). Fiber optic connections from the Launch Control to the Vehicle

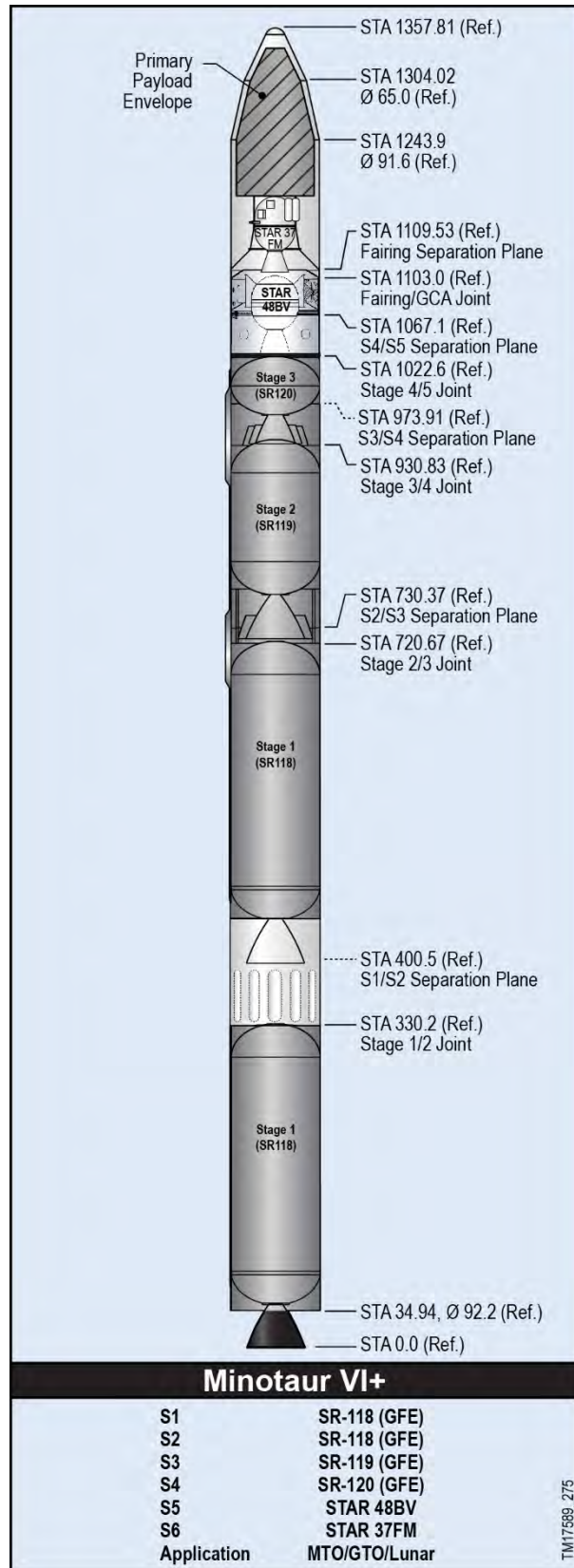

Figure 2.3.6.4-1. Minotaur VI+ Vehicle Configuration

Interface consoles are used for efficient, high bandwidth communications, eliminating the need for copper wire between locations. The Vehicle Interface consoles provide the junction from fiber optic cables to the cables that directly interface with the vehicle. Figure 2.4-2 depicts the functional block diagram of the LSE. All Minotaur EGSE is compliant with the Department of Defense Instruction 8510.01, DoD Information Assurance Certification and Accreditation Process (DIACAP). Some launch sites have a separate Support Equipment Building (SEB) that can accommodate additional payload equipment.

The LCR serves as the control center during the launch countdown. The number of personnel that can be accommodated is dependent on the launch site facilities. At a minimum, the LCR will accommodate NGIS personnel controlling the vehicle, two Range Safety representatives (ground and flight safety), and the Air Force Mission Manager. Mission-unique customer-supplied payload consoles can be supported in the LCR, and payload equipment required at the launch pad can be supported in the LEV or SEB, if available, within the constraints of the launch site facilities. Interface to the payload through the Minotaur IV payload umbilicals provides the capability for direct monitoring of payload functions. Payload personnel accommodations will be handled on a mission-specific basis.



Figure 2.4-1. Multiple Sets of MGSE Are Available to Support Parallel Missions

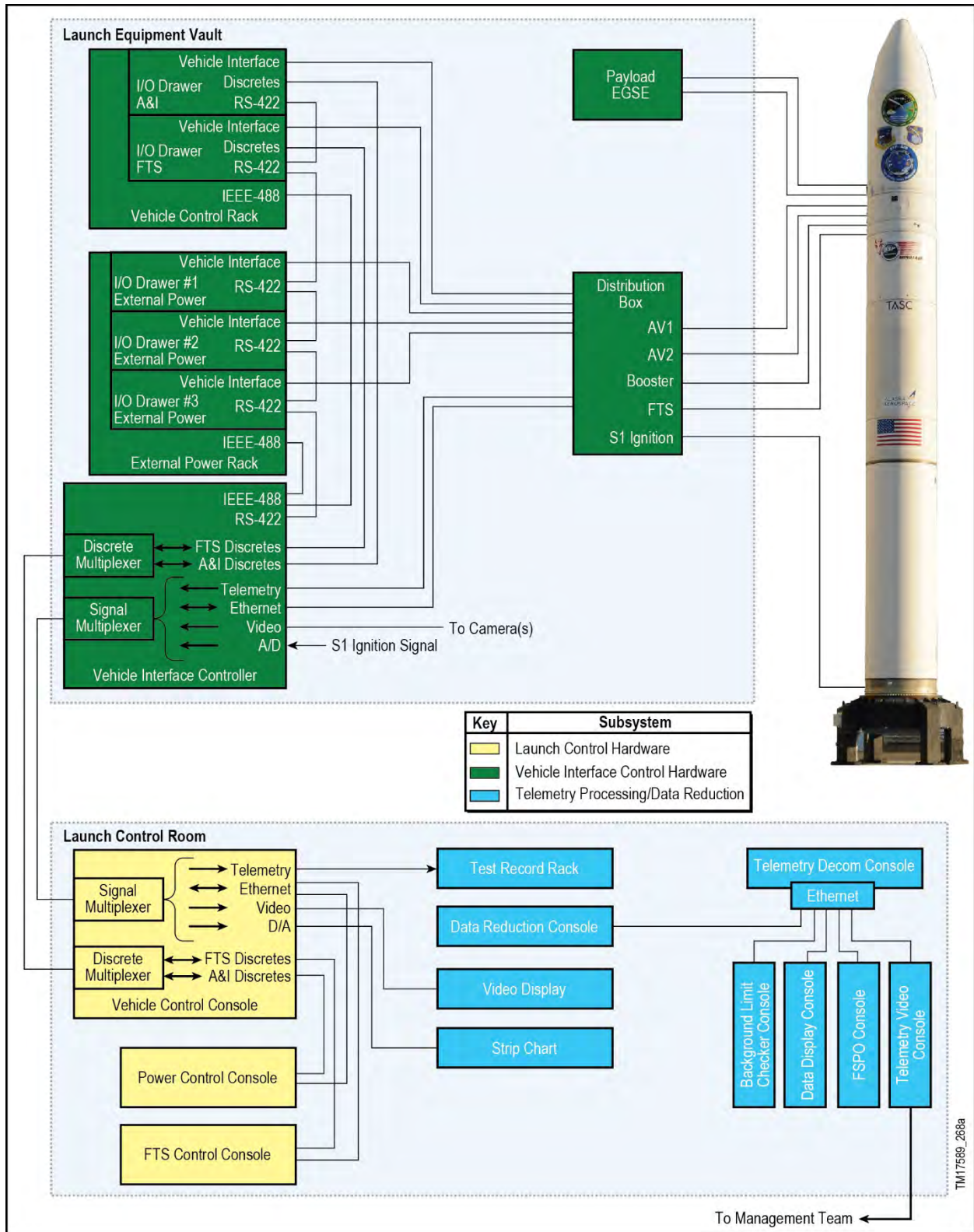

Figure 2.4-2. Functional Block Diagram of LSE

This page left intentionally blank.

3. GENERAL PERFORMANCE

3.1. Mission Profiles

Minotaur IV family of Launch Vehicles can attain a range of posigrade and retrograde inclinations through the choice of launch sites made available by the readily adaptable nature of the Minotaur launch system. A generic mission profile to a sun-synchronous orbit is shown in Figure 3.1-1. All performance parameters presented within this User's Guide are typical for most expected payloads. However, performance may vary depending on unique payload or mission characteristics. Specific requirements for a particular mission should be coordinated with OSP. Once a mission is formally initiated, the requirements will be documented in the Mission Requirements Document (MRD). Further detail will be captured in the Payload-to-Launch Vehicle Interface Control Document (ICD).

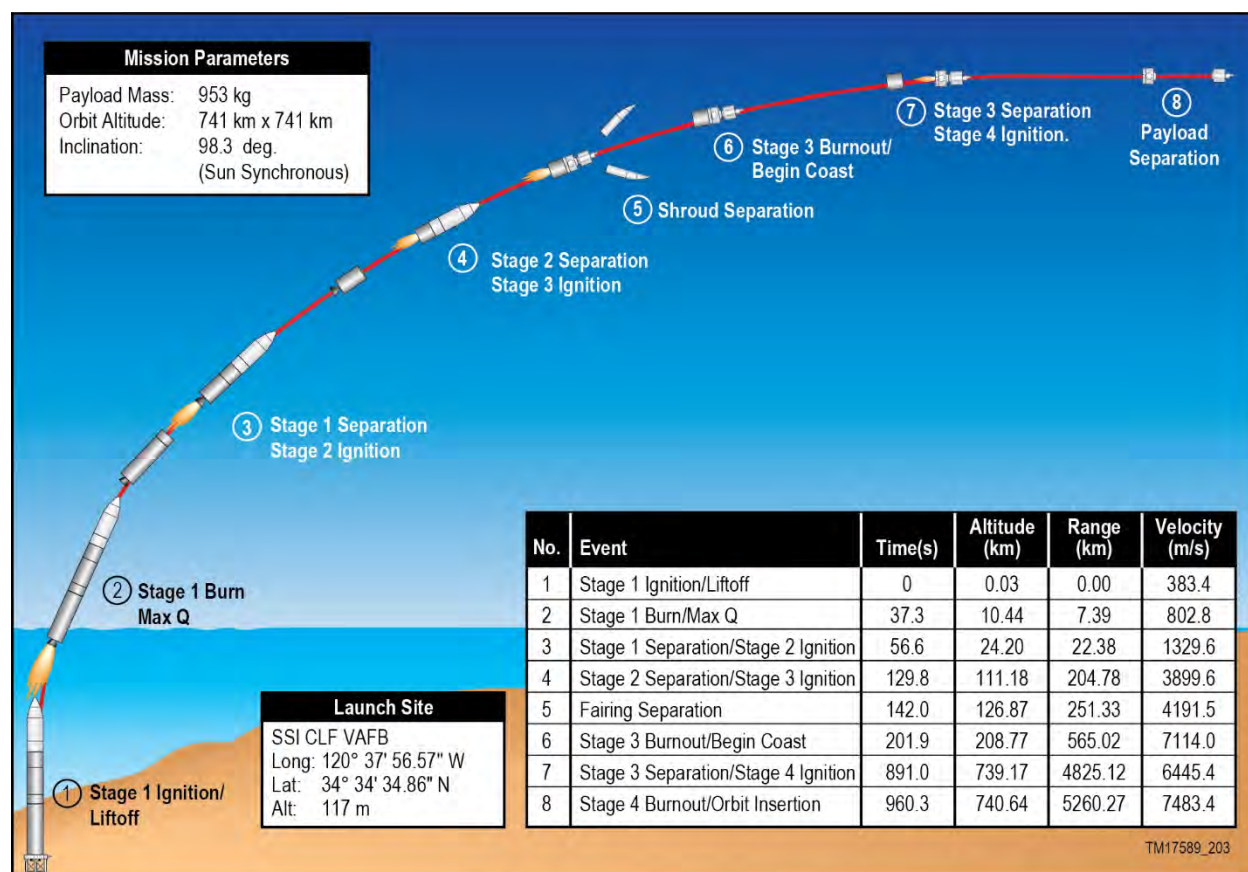

Figure 3.1-1. Generic Minotaur IV Mission Profile

3.2. Launch Sites

Depending on the specific mission, Minotaur vehicles can operate from East and West Coast launch sites as shown in Figure 3.2-1. The corresponding range inclination capabilities are shown in Figure 3.2-2. Specific Minotaur vehicle performance parameters within those launch inclination ranges are presented in Section 3.3. Per OSP-3 contract requirements, baseline launch sites were established and are shown in Table 3.2-1.

Table 3.2-1. Baseline Launch Sites for the Minotaur IV Family of Launch Vehicles

Launch Vehicle	Baseline Launch Site
Minotaur IV/IV+	VAFB
Minotaur V	WFF
Minotaur VI/VI+	KLC

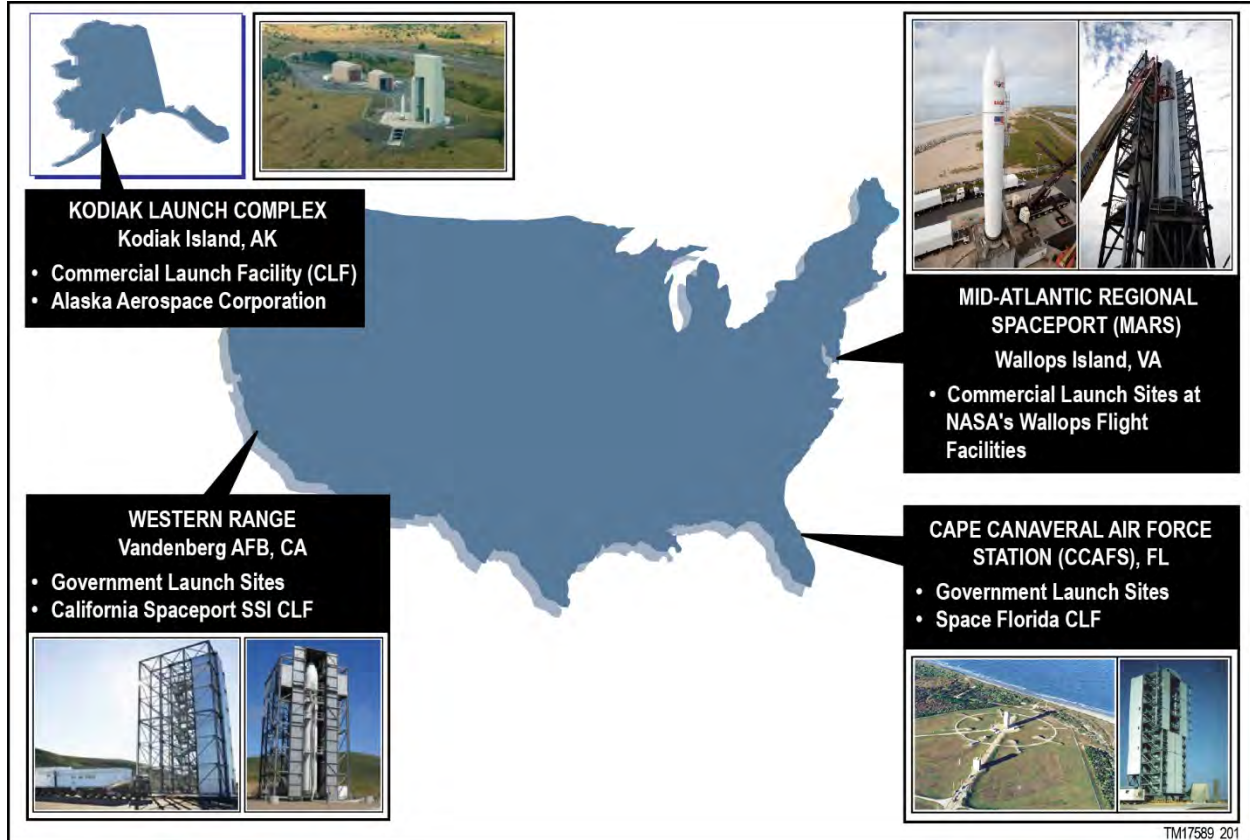

Figure 3.2-1. Flexible Processing and Portable GSE Allows Operations from Multiple Ranges or Austere Site Options

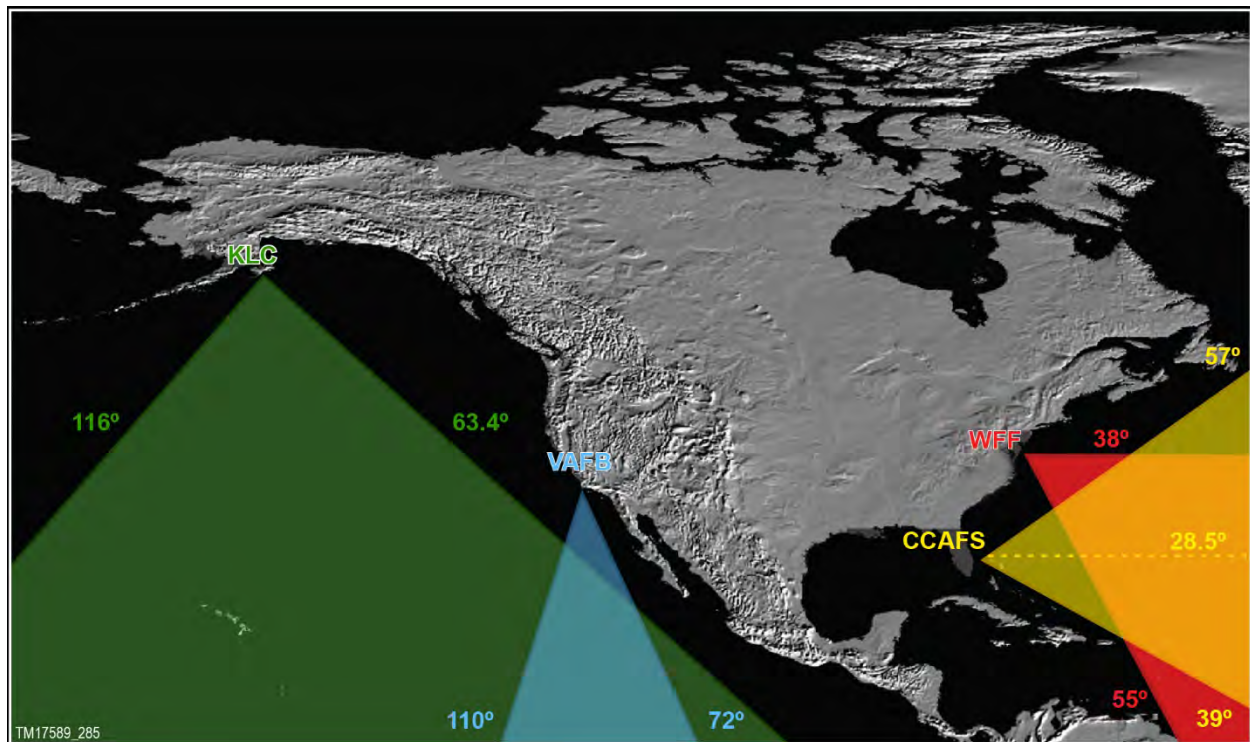

Figure 3.2-2. Launch Site Inclinations

3.2.1. Western Launch Sites

For missions requiring high inclination orbits (greater than 60°), launches can be conducted from facilities at VAFB or Kodiak Island, AK, as shown in Figure 3.2-2. Inclinations below 72° from VAFB are possible, but require an out-of-plane dogleg, thereby reducing payload capability. Minotaur IV is nominally launched from the California Spaceport facility, Space Launch Complex 8 (SLC-8) operated by Spaceport Systems International (SSI), on South VAFB. The launch facility at Kodiak Island, operated by the Alaska Aerospace Corporation (AAC), can accommodate the larger Minotaur V and VI vehicles and has been used for both orbital and suborbital launches including past launches of Minotaur IV.

3.2.2. Eastern Launch Sites

For easterly launch azimuths to achieve orbital inclinations between 28.5° and 55°, launches can be conducted from facilities at Cape Canaveral Air Force Station, FL (CCAFS) or Wallops Island, VA (WFF). Launches from Florida will nominally use the Space Florida launch facilities at LC-46 on CCAFS which can accommodate any of the Minotaur vehicle configurations. Typical inclinations are from 28.5° to 50°; however, higher inclination trajectories may require northerly ascent trajectories. These would need to consider the potential of European overflight and require range safety assessment. The Mid-Atlantic Regional Spaceport (MARS) facilities at the WFF may be used for inclinations from 37.8° to 55°. Some inclinations and/or altitudes may have reduced performance due to range safety considerations and will need to be evaluated on a case-by-case mission-specific basis.

3.2.3. Alternate Launch Sites

Other launch facilities can be readily used given the flexibility designed into the Minotaur IV vehicle, ground support equipment, and the various interfaces. NGIS has experience launching vehicles from a variety of sites around the world. To meet the requirements of performing mission operations from alternative, austere launch sites, NGIS can provide self contained, transportable shelters for launch operations as an unpriced option. The mobile equivalent of the LCR is the Launch Support Van (LSV), and the mobile LEV is the Launch Equipment Van.

3.3. Performance Capability

Minotaur IV performance curves for circular orbits of various altitudes and inclinations are shown on the next several pages for launches from all four Spaceports in metric and English units. These performance curves provide the total mass above the standard, non-separating interface. The mass of the separation system, and any Payload Adapter (PLA) that is attached to the 38.81 in. interface, is to be accounted for in the payload mass allocation. Table 3.3-1 shows a number of common options and the mass associated with each. Figures 3.3-1 and 3.3-2 show relative performance of the Minotaur IV family of launch vehicles for representative launches from KLC and CCAFS.

**Table 3.3-1. Common Mission Options and Associated Masses
(These Masses Must Be Subtracted from the LV Performance)**

Option	Total Mass (kg) <i>(These Masses Must Be Subtracted from the LV Performance)</i>	Portion of Total Mass That Remains with SV Post Separation (kg)
Enhanced Telemetry	9.85	0
TDRSS	8.54	0
62" Payload Adapter Cone ¹	-10.32	0
Two Piece Payload Adapter Cone (92" to 38") ¹	9.07	0
38" NGIS Separation System ²	12.24	4.0
38" RUAG Low Shock Separation System (937S) ²	19.89	6.16
38" RUAG Separation System (937B) ²	18.25	5.18
38" Lightband ²	8.85	2.52
38" Softride and Ring ³	9 to 18	0

Notes: ¹ For more information on these payload cone options, refer to Table 5.2.4.1-1.

² For more information on these separation system options, refer to Table 5.2.5-1.

³ A range is provided for the softride option; actual mass is based on satellite requirements.

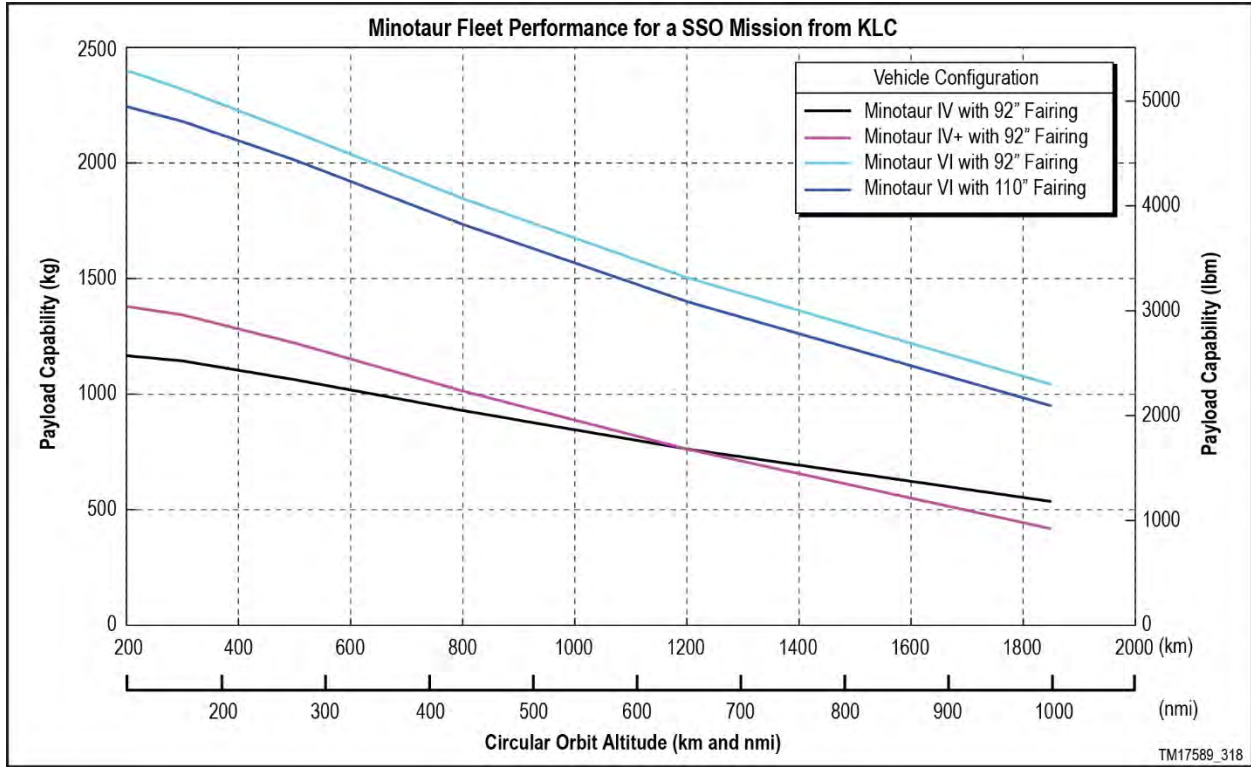

Figure 3.3-1. Minotaur IV Fleet Comparison Performance Curves for SSO Out of KLC

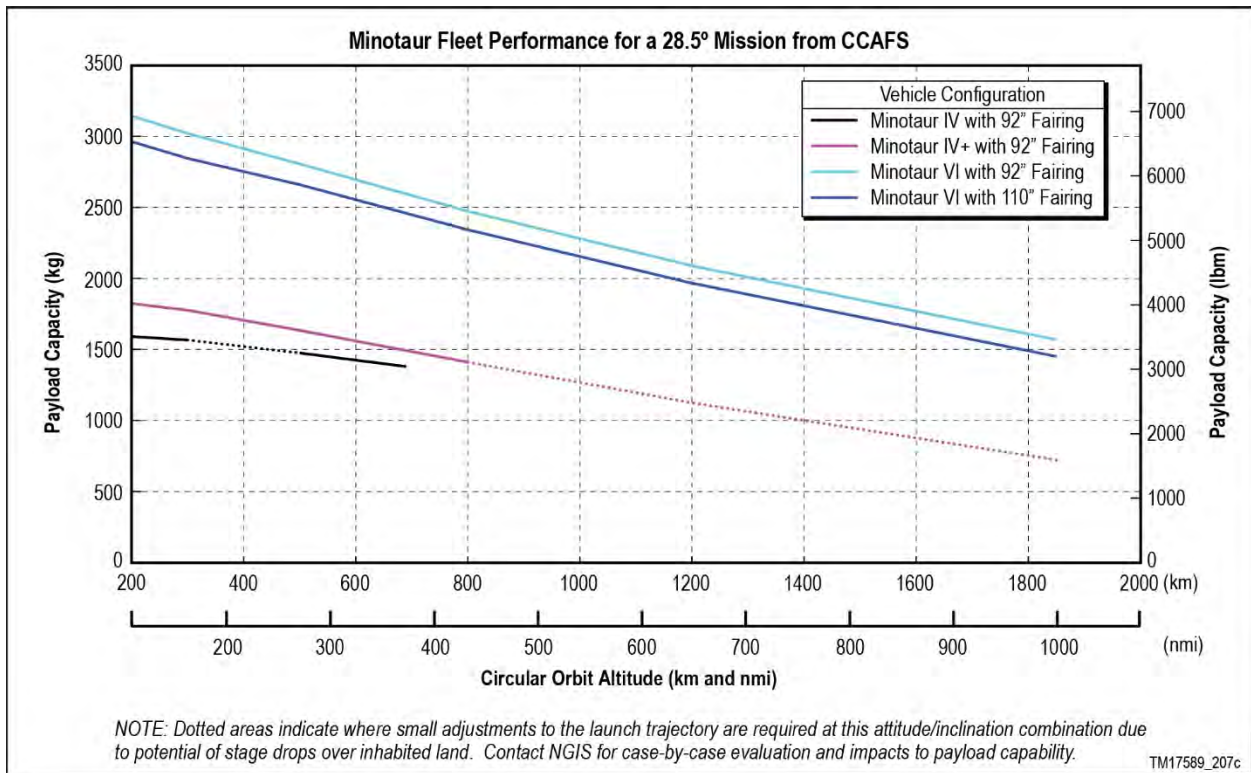

Figure 3.3-2. Minotaur IV Fleet Comparison Performance Curves for 28.5° Inclination Orbits Out of CCAFS

3.3.1. Minotaur IV LEO Orbits

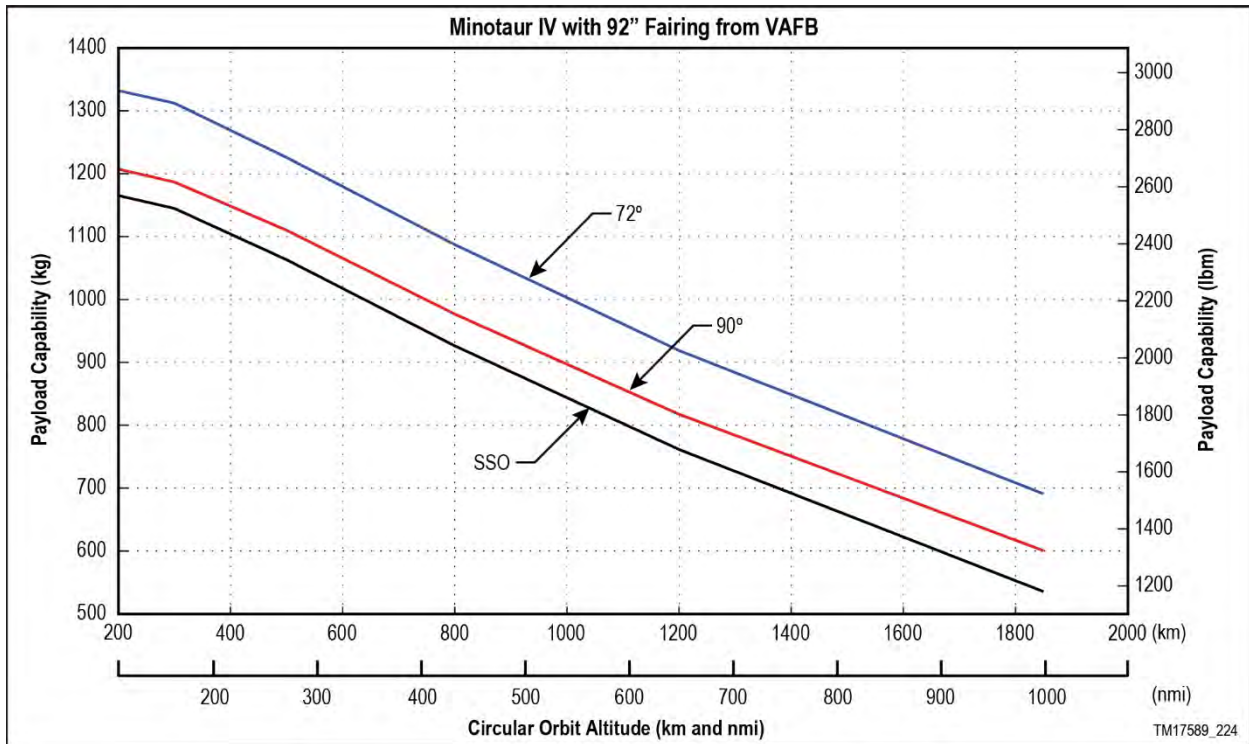

Figure 3.3.1-1. Minotaur IV Performance Curves for VAFB Launches

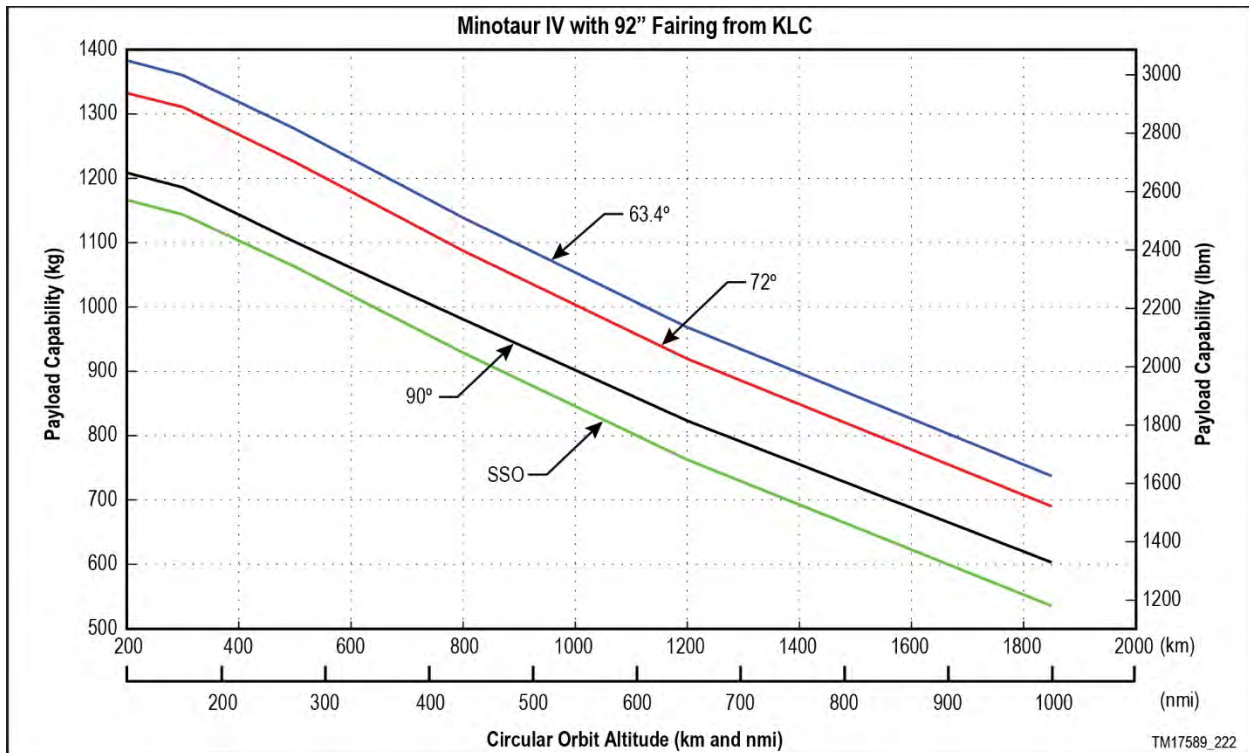

Figure 3.3.1-2. Minotaur IV Performance Curves for KLC Launches

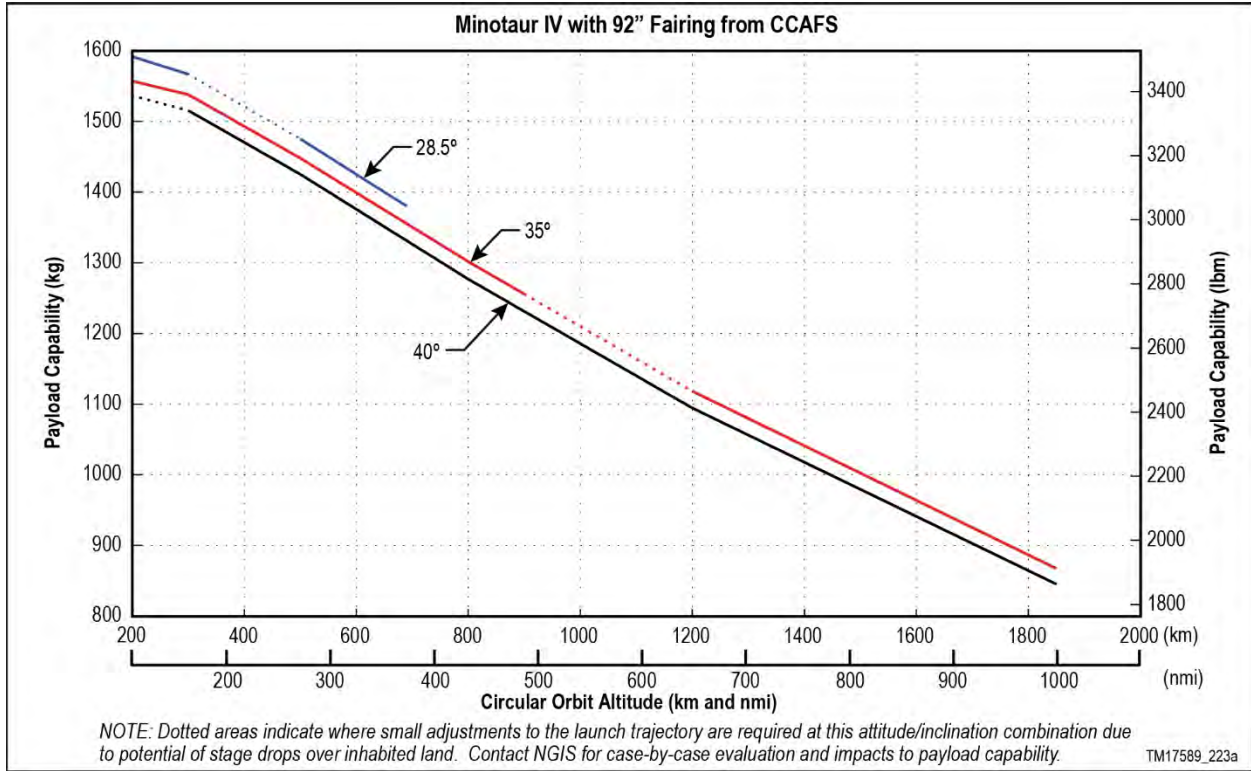

Figure 3.3.1-3. Minotaur IV Performance Curves for CCAFS Launches

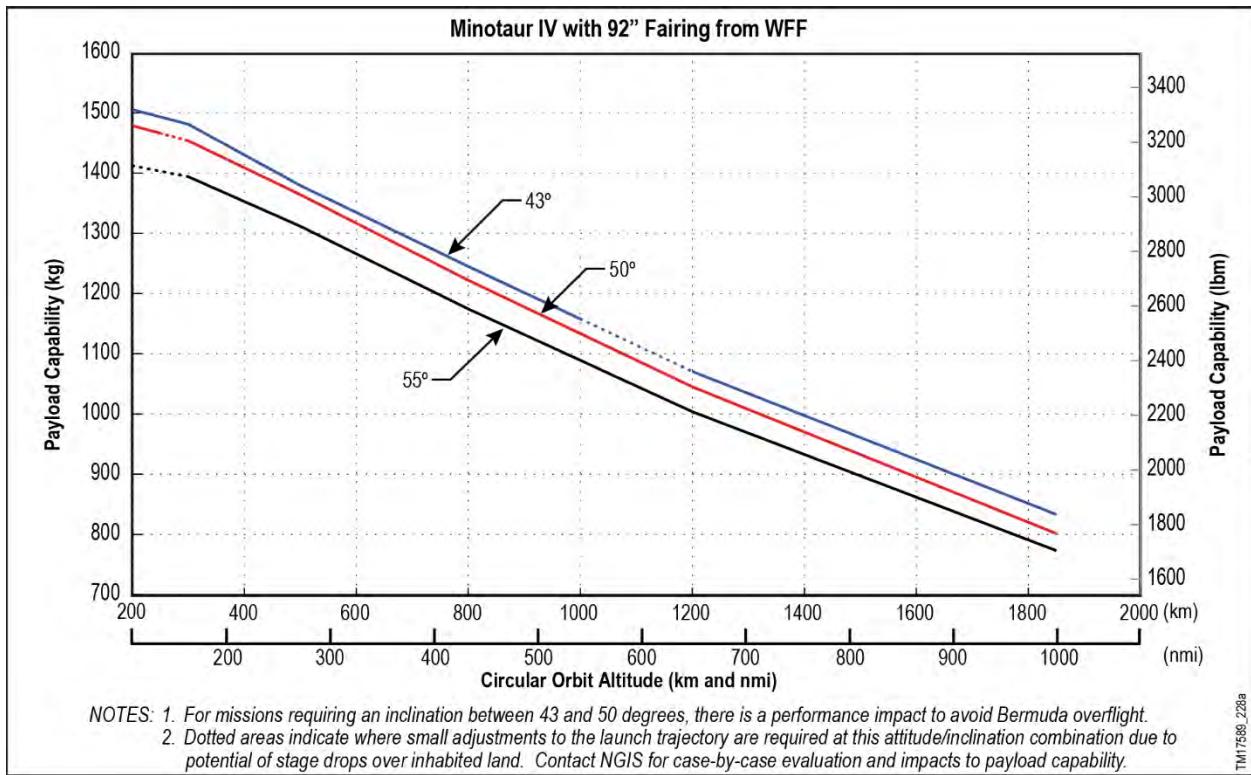

Figure 3.3.1-4. Minotaur IV Performance Curves for WFF Launches

3.3.2. Minotaur IV+ LEO Orbits

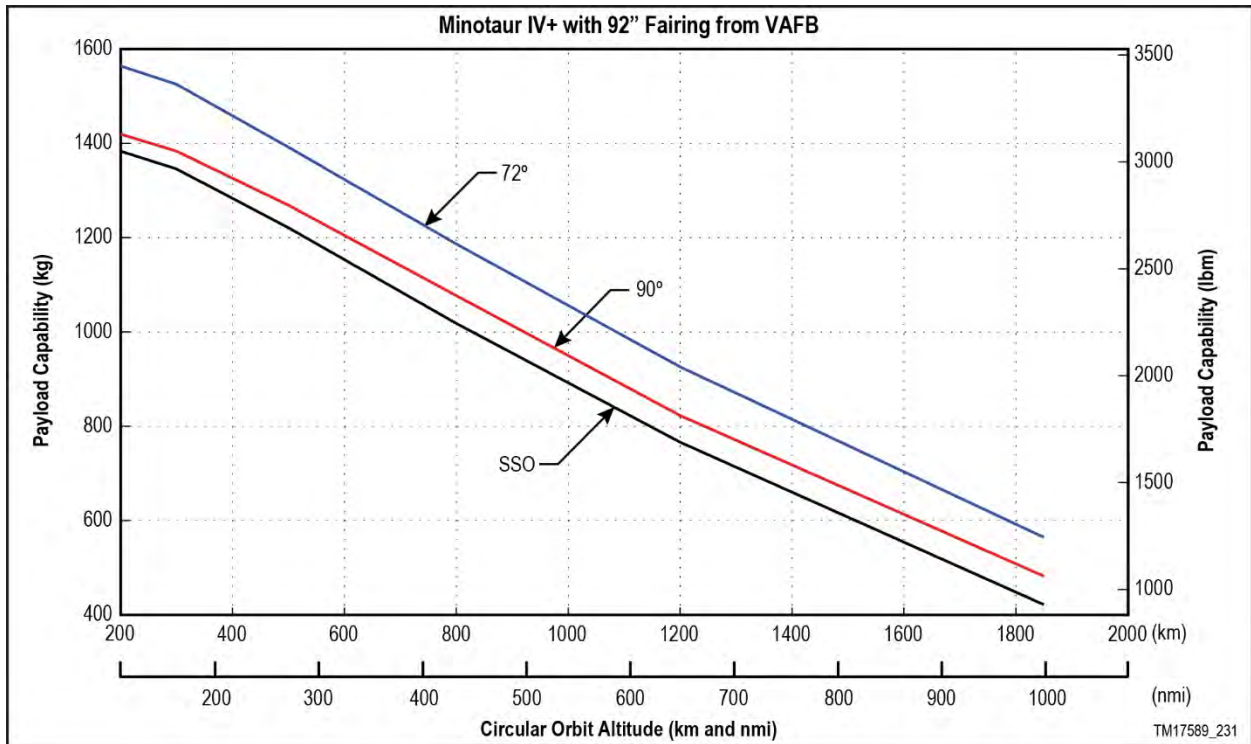

Figure 3.3.2-1. Minotaur IV+ Performance Curves for VAFB Launches

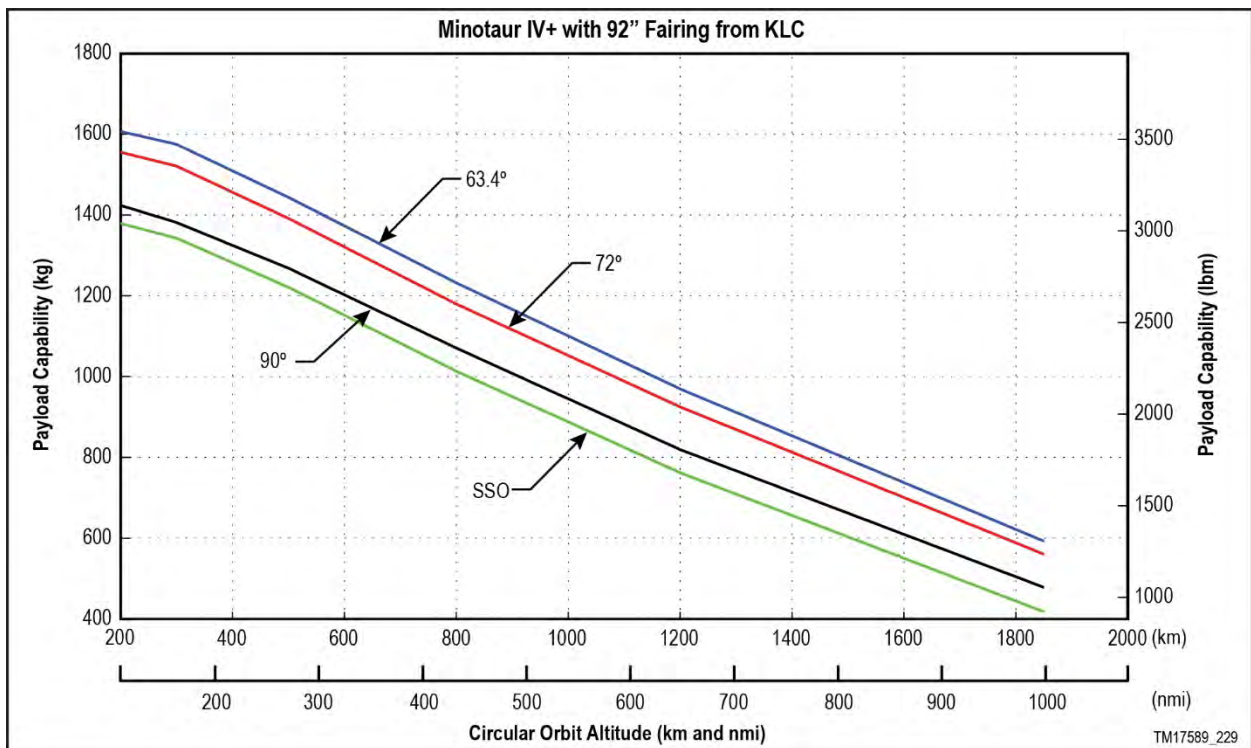

Figure 3.3.2-2. Minotaur IV+ Performance Curves for KLC Launches

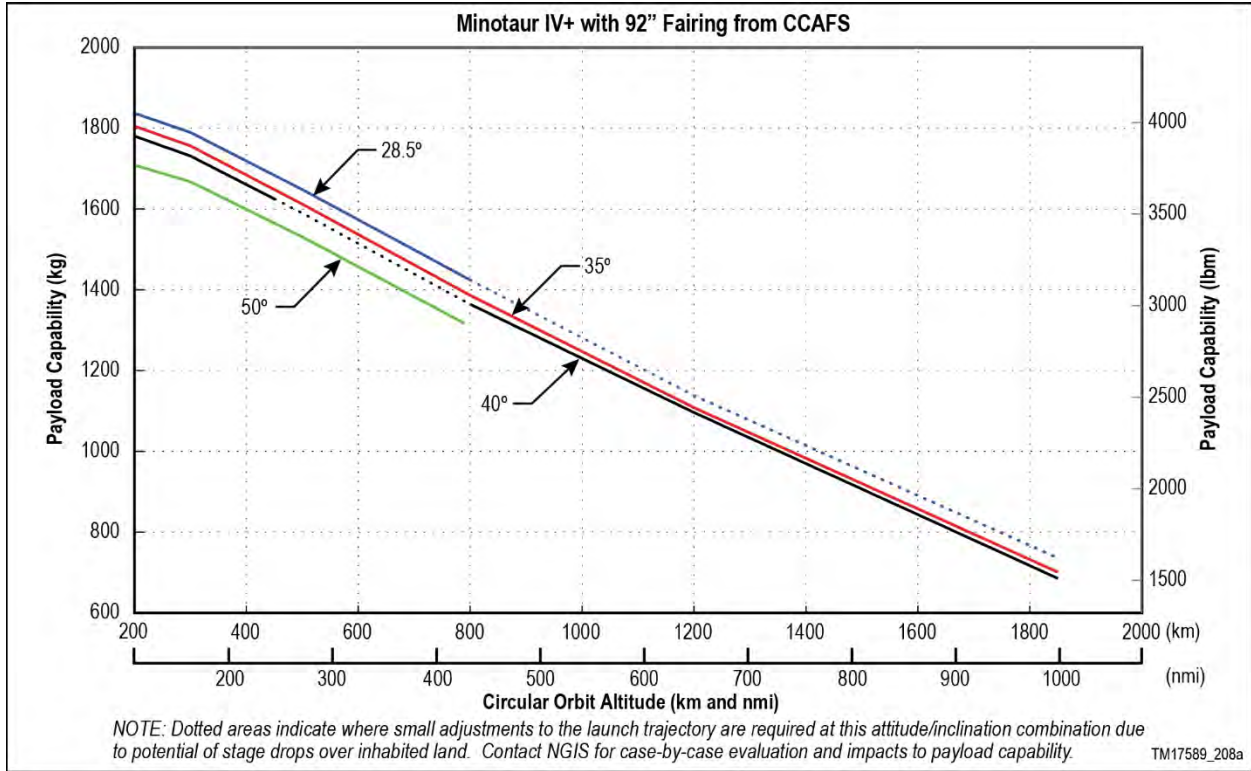

Figure 3.3.2-3. Minotaur IV+ Performance Curves for CCAFS Launches

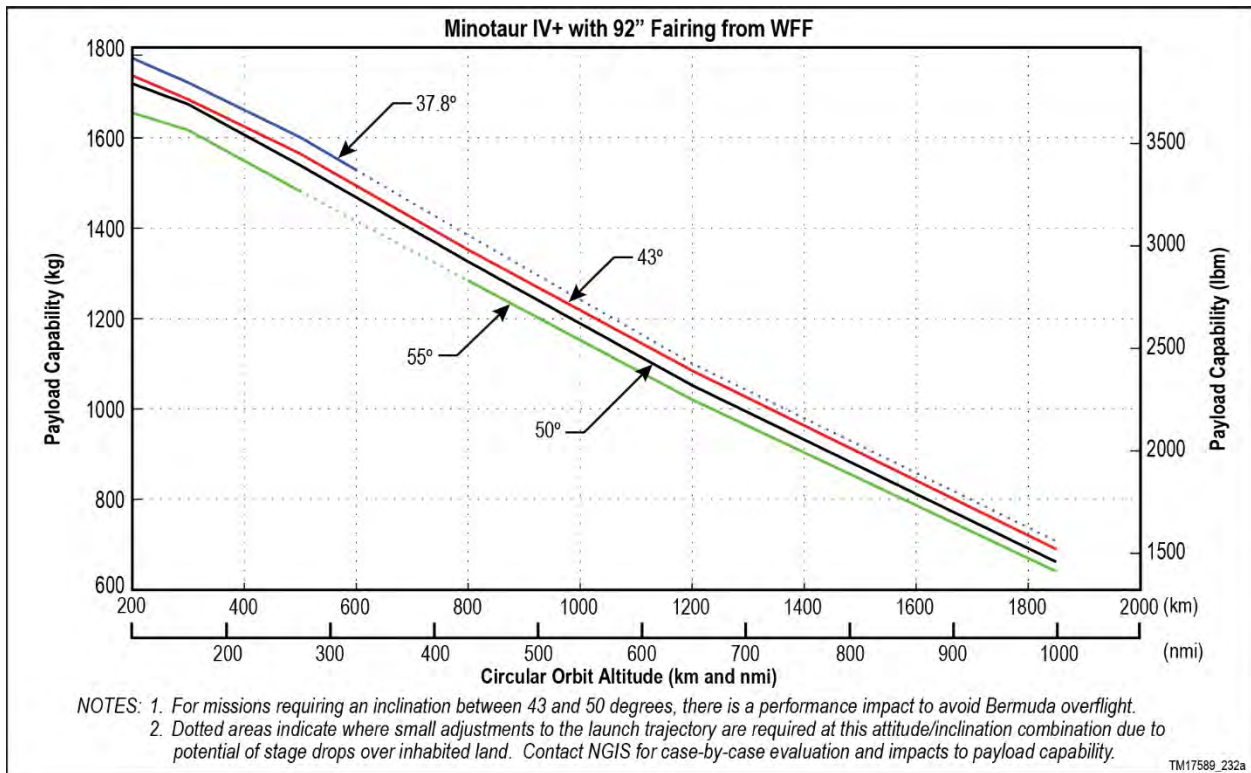

Figure 3.3.2-4. Minotaur IV+ Performance Curves for WFF Launches

3.3.3. Minotaur VI LEO Orbits

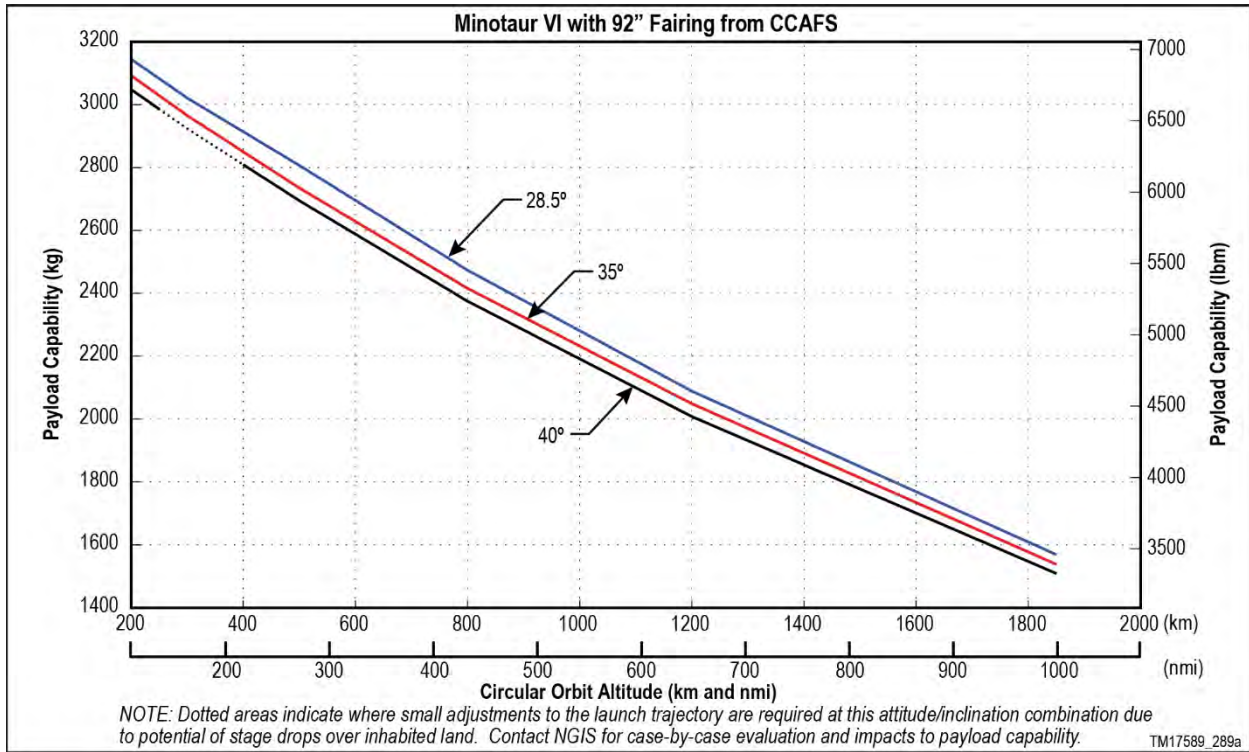

Figure 3.3.3-1. Minotaur VI (92" Fairing) Performance Curves for CCAFS Launches

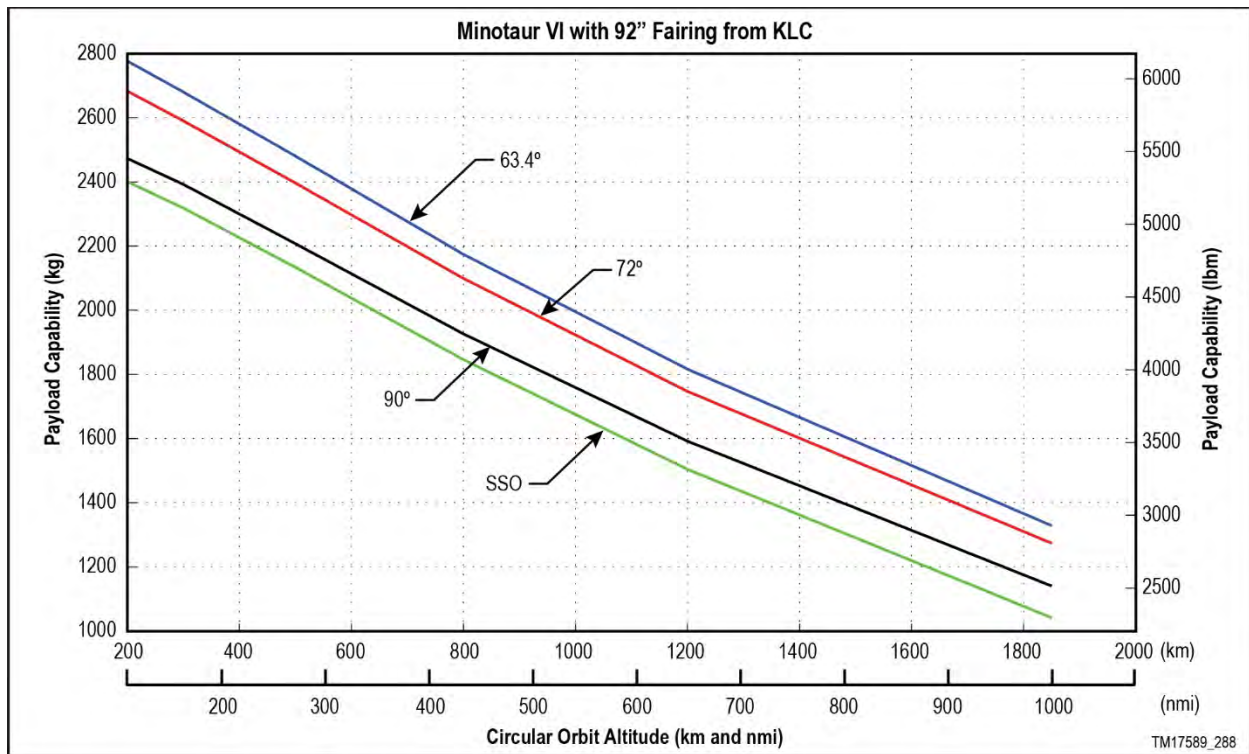

Figure 3.3.3-2. Minotaur VI (92" Fairing) Performance Curves for KLC Launches

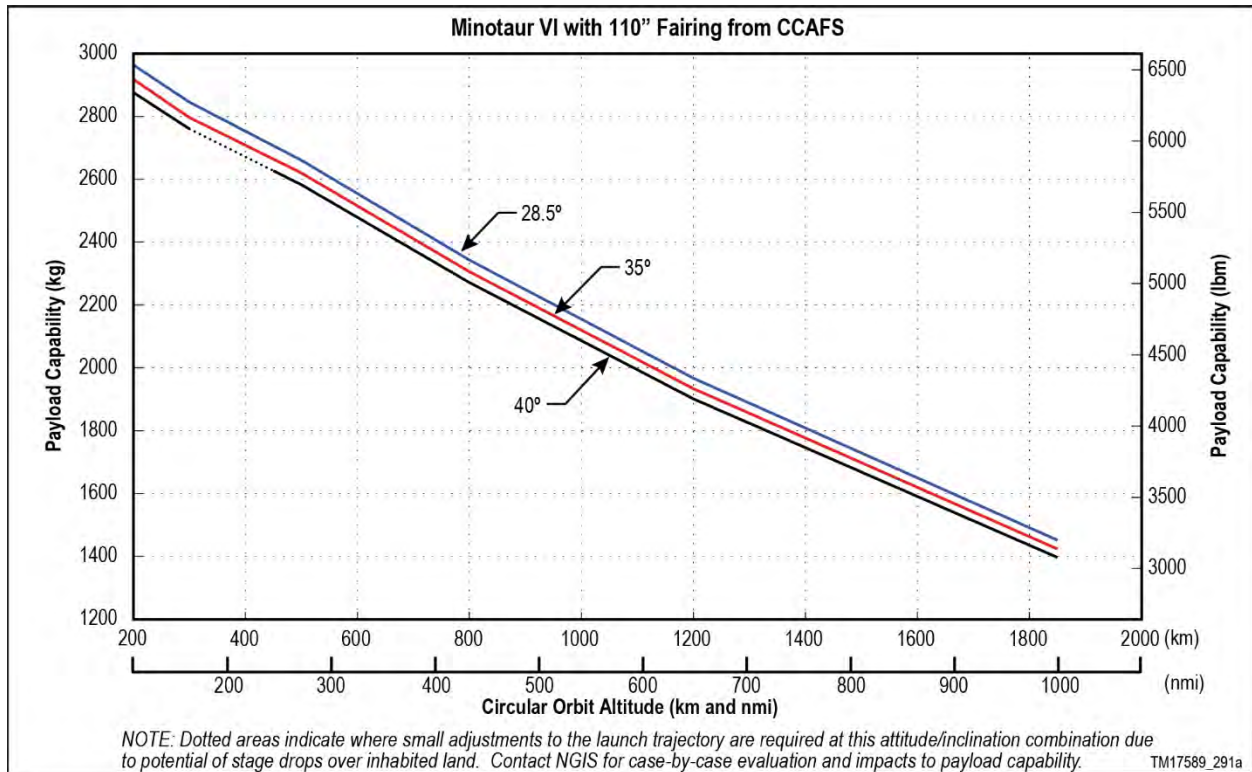

Figure 3.3.3-3. Minotaur VI (110" Fairing) Performance Curves for CCAFS Launches

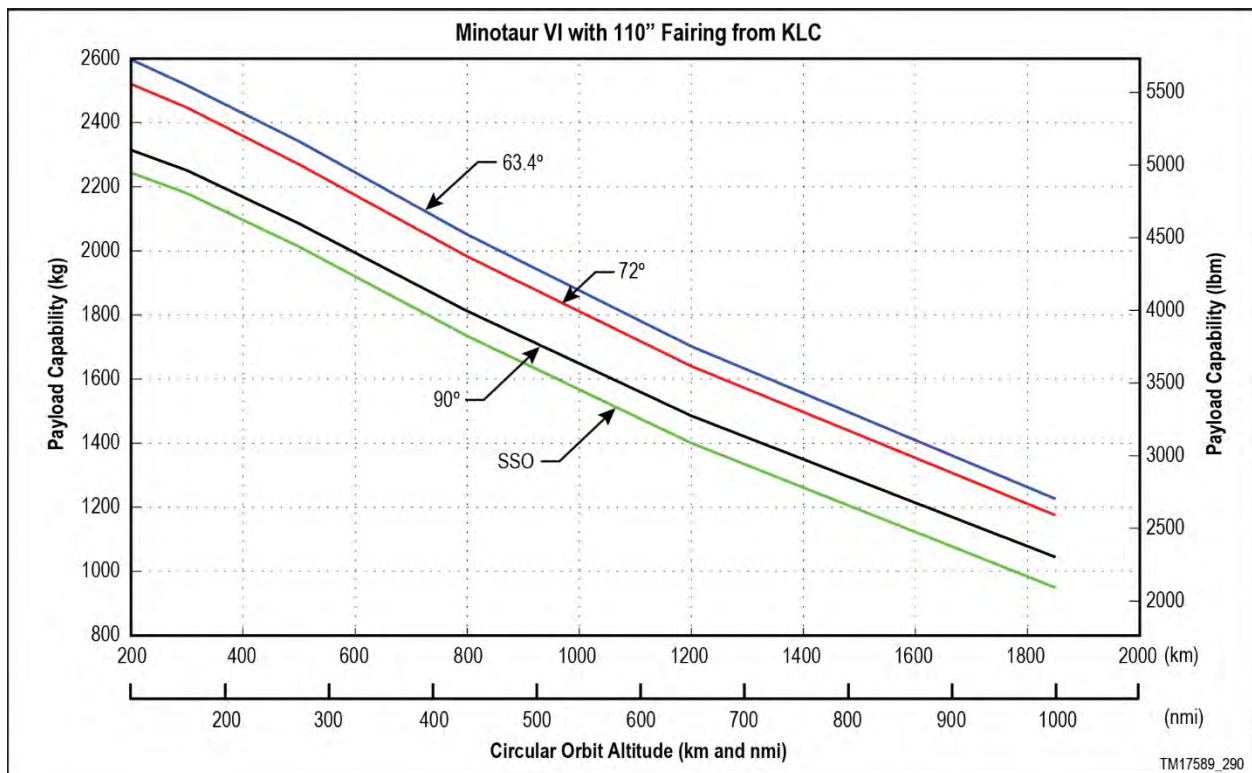

Figure 3.3.3-4. Minotaur VI (110" Fairing) Performance Curves for KLC Launches

3.3.4. Elliptical Orbits and High Energy Orbits

The Minotaur IV+, V, and VI+ are capable of supporting elliptical and high energy orbits, including Geostationary Transfer Orbits (GTO), Medium Transfer Orbits (MTO), and Trans-Lunar Injection (TLI), as shown in Figures 3.3.4-1 through 3.3.4-5 and Tables 3.3.4-1 through 3.3.4-3. NGIS evaluates specific high energy or elliptical missions on a case by case basis.

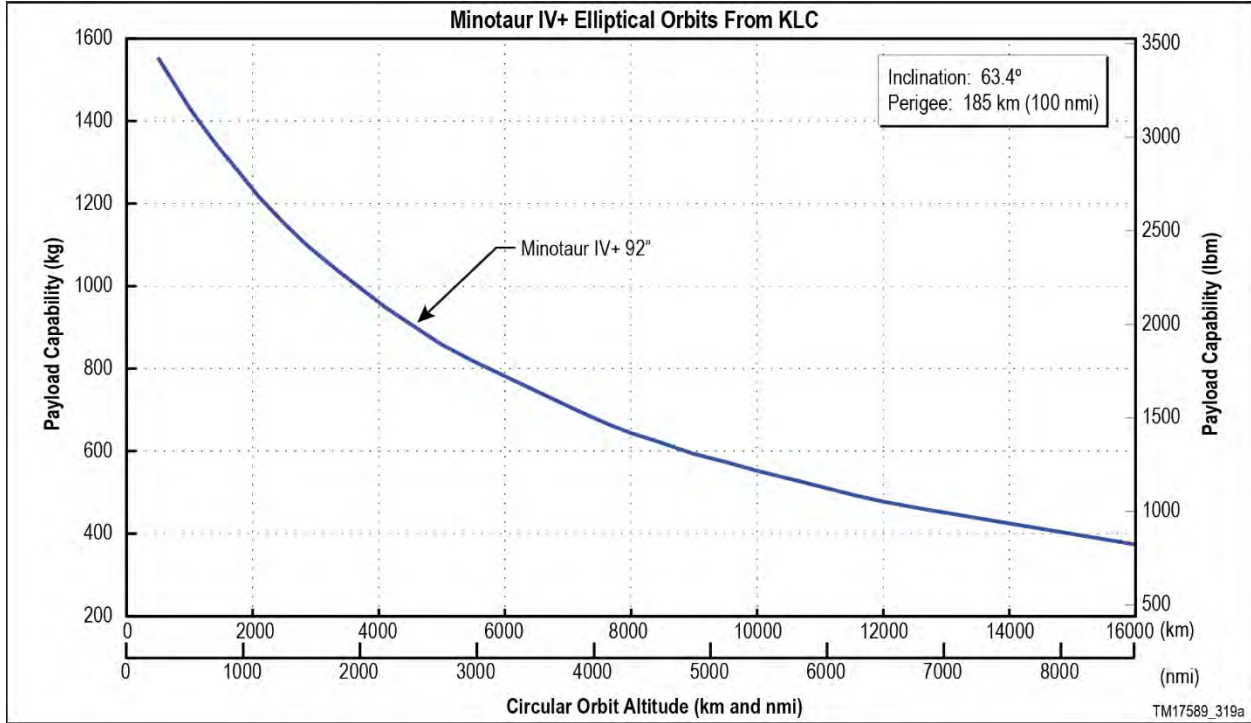

Figure 3.3.4-1. Minotaur IV+ Elliptical Orbits Performance Curve for KLC Launches

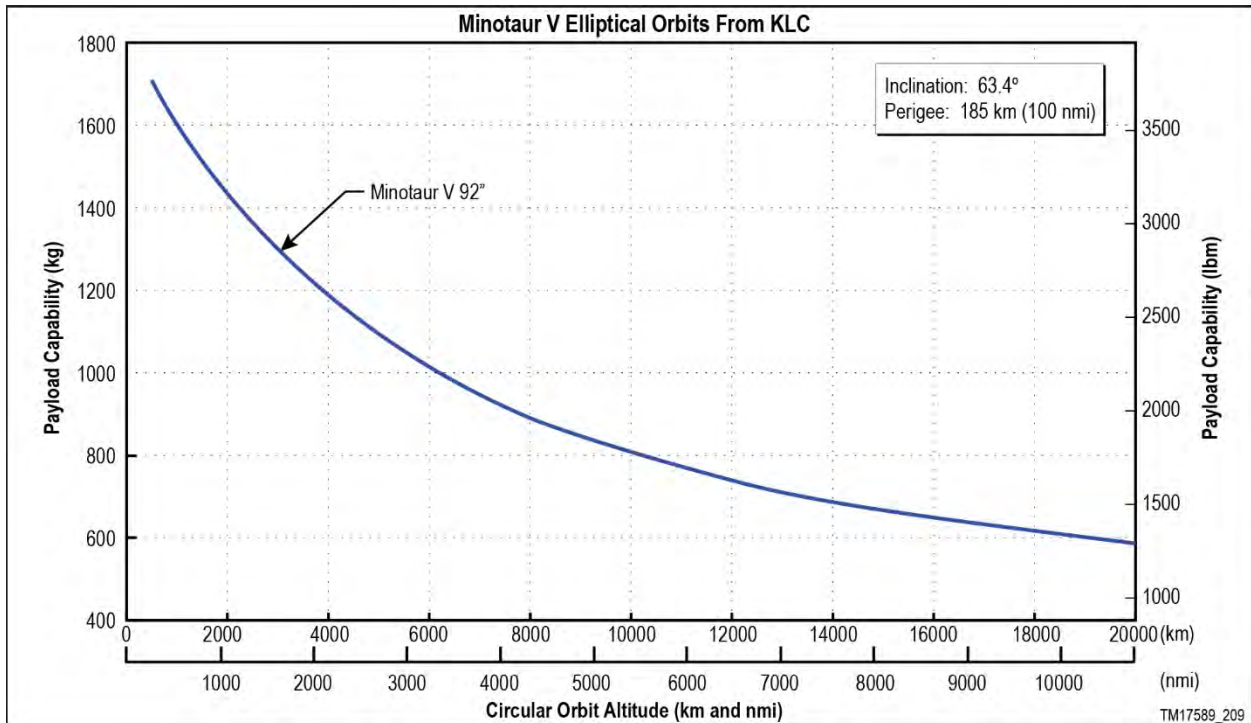

Figure 3.3.4-2. Minotaur V Elliptical Orbits Performance Curve for KLC Launches

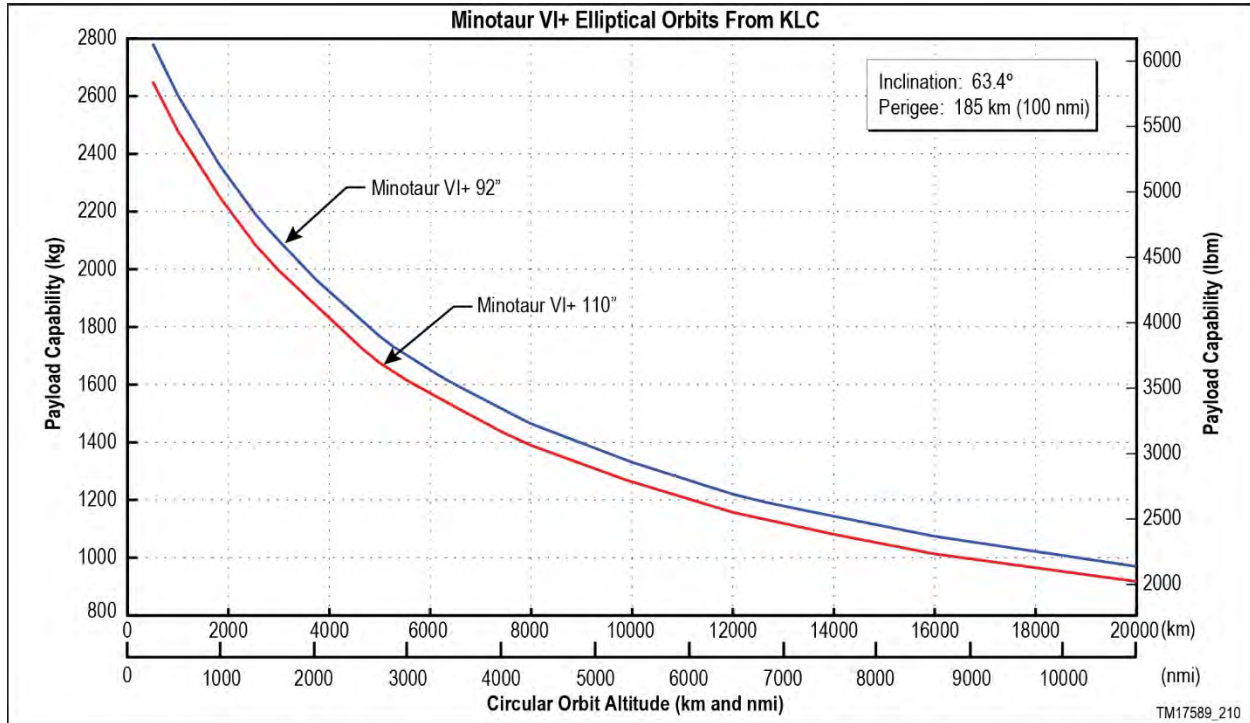

Figure 3.3.4-3. Minotaur VI+ Elliptical Orbits Performance Curves for KLC Launches

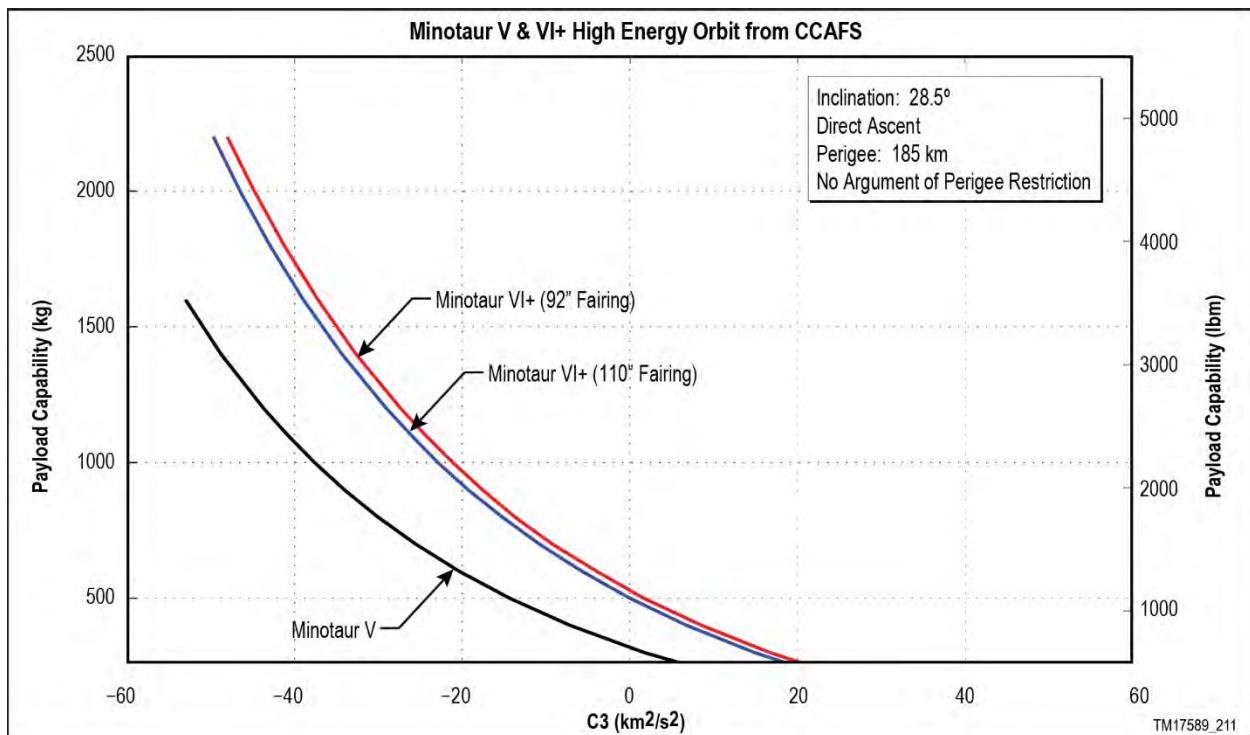

Figure 3.3.4-4. Minotaur V/VI+ High Energy Orbit Performance Curves for CCAFS Launches

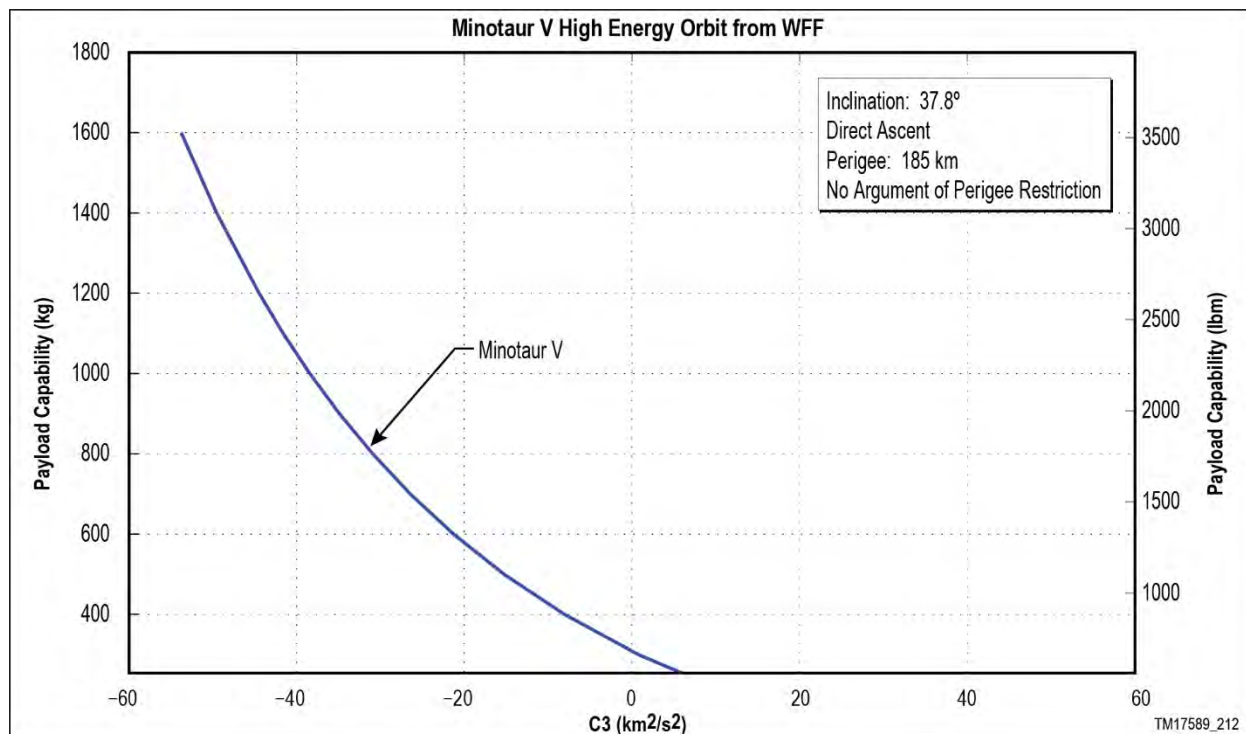

Figure 3.3.4-5. Minotaur V High Energy Orbit Performance Curve for WFF Launches

Table 3.3.4-1. Geosynchronous Transfer Orbit (GTO) Performance For CCAFS

GTO from CCAFS: C3 = -16.3 km ² /s ² Argument of Perigee = 180° Inclination = 28.5°	
Vehicle	Payload Capability (Inclination 28.5°) Argument of Perigee = 180
Minotaur V	532 kg 1173 lbf
Minotaur VI+ (92" Fairing)	866 kg 1909 lbf
Minotaur VI+ (110" Fairing)	819 kg 1806 lbf

Table 3.3.4-2. Medium Transfer Orbit (MTO) Performance For CCAFS

MTO from CCAFS: C3 = -24.0 km ² /s ²		
Vehicle	Payload Capability (Inclination 55°) No Argument of Perigee Constraint	Payload Capability (Inclination 39°) Argument of Perigee = 180°
Minotaur V	Not Achievable (Due to stage drops over land)	650 kg 1433 lbf
Minotaur VI+ (92" Fairing)	991 kg 2185 lbf	1025 kg 2261 lbf
Minotaur VI+ (110" Fairing)	935 kg 2063 lbf	988 kg 2179 lbf

Table 3.3.4-3. Medium Transfer Orbit (MTO) Performance For WFF

MTO from WFF: C3 = -24.0 km ² /s ²		
Vehicle	Payload Capability (Inclination 55°) No Argument of Perigee Constraint	Payload Capability (Inclination 39°) Argument of Perigee = 180°
Minotaur V	603 kg 1329 lbm	649 kg 1432 lbm

3.4. Injection Accuracy

Minotaur IV injection accuracy limits are summarized in Table 3.4-1. Better accuracy can likely be provided depending on specific mission characteristics. For example, heavier payloads will typically have better insertion accuracy, as will higher orbits. Furthermore, an enhanced option for increased insertion accuracy is also available (Section 8.9) that utilizes the flight proven Hydrazine Auxiliary Propulsion System (HAPS).

Table 3.4-1. Minotaur IV Injection Accuracy

Error Type	Tolerance (Worst Case)	Error Source
Altitude (Insertion Apse)	±18.5 km (10 nmi)	Stage 4 motor performance uncertainty and guidance algorithm uncertainty
Altitude (Non-Insertion Apse)	±92.6 km (50 nmi)	Stage 4 motor performance and guidance algorithm uncertainty and navigation (INS) error
Altitude (Mean)	±55.6 km (30 nmi)	Stage 4 motor performance and guidance algorithm uncertainty and navigation (INS) error
Inclination	±0.2°	Guidance algorithm uncertainty and navigation (INS) error

3.5. Payload Deployment

Following orbit insertion, the Minotaur IV avionics subsystem can execute a series of ACS maneuvers to provide the desired initial payload attitude prior to separation. This capability may also be used to incrementally reorient Stage 4 for the deployment of multiple spacecraft with independent attitude requirements. Either an inertially-fixed or spin-stabilized attitude may be specified by the customer. The maximum spin rate for a specific mission depends upon the spin axis moment of inertia of the payload and the amount of ACS propellant needed for other attitude maneuvers. Table 3.5-1 provides the typical payload pointing and spin rate accuracies.

Table 3.5-1. Typical Pre-Separation Payload Pointing and Spin Rate Accuracies

Error Type	Angle	Rate	
3-Axis	Yaw	±1.0°	≤1.0°/sec
	Pitch	±1.0°	≤1.0°/sec
	Roll	±1.0°	≤1.0°/sec
Spinning	Spin Axis	±1.0°	≤10 rpm
	Spin Rate	--	±3°/sec

3.6. Payload Separation

Payload separation dynamics are highly dependent on the mass properties of the payload and the particular separation system utilized. The primary parameters to be considered are payload tip-off and the overall separation velocity.

Payload tip-off refers to the angular velocity imparted to the payload upon separation due to payload Center-of-Gravity (CG) offsets and an uneven distribution of torques and forces. Separation system options are discussed further in Section 5.2.4. NGIS performs a mission-specific tip-off analysis for each payload.

Separation velocities are driven by the need to prevent recontact between the payload and the Minotaur final stage after separation. The value will typically be 0.6 to 0.9 m/sec (2 to 3 ft/sec).

3.7. Collision/Contamination Avoidance Maneuver

Following orbit insertion and payload separation, the Minotaur final stage will perform a Collision/Contamination Avoidance Maneuver (C/CAM). The C/CAM minimizes both payload contamination and the potential for recontact between Minotaur hardware and the separated payload. NGIS will perform a recontact analysis for post-separation events.

A typical C/CAM begins shortly after payload separation. The launch vehicle performs a 90° yaw maneuver designed to direct any remaining motor impulse in a direction which will increase the separation distance between the two bodies. After a delay to allow the distance between the spacecraft and Stage 4 to increase to a safe level, the launch vehicle begins a “crab-walk” maneuver to impart a small amount of delta velocity, increasing the separation between the payload and the final stage.

Following the completion of the C/CAM maneuver as described above and any remaining maneuvers, such as separating other small secondary payloads or downlinking of delayed telemetry data, the ACS valves are opened and the remaining nitrogen propellant is expelled to meet International Space Debris guidelines.

4. PAYLOAD ENVIRONMENT

CAUTION

The predicted environments provided in this user's guide are for initial planning purposes only.

Environments presented here bound typical mission parameters, but should not be used in lieu of mission-specific analyses. Mission-specific levels are provided as a standard service and documented or referenced in the mission ICD.

This section provides details of the predicted environmental conditions the payload will experience during Minotaur ground operations, powered flight, and launch system on-orbit operations.

Minotaur ground operations include payload integration and encapsulation within the fairing, subsequent transportation to the launch site and final vehicle integration activities. Powered flight begins at Stage 1 ignition and ends at final stage burnout. Minotaur on-orbit operations begin after final stage burnout and end following payload separation. To more accurately define simultaneous loading and environmental conditions, the powered flight portion of the mission is further subdivided into smaller time segments bounded by critical, transient flight events such as motor ignition, stage separation, and transonic crossover.

The environmental design and test criteria presented have been derived using measured data obtained from many different sources, including Minotaur flights, Peacekeeper motor static fire tests, and other NGIS system development tests and flights. The predicted levels presented are intended to be representative of a standard mission and contain margins consistent with MIL-STD 1540B. Satellite mass, geometry and structural components vary greatly and will result in significant differences from mission to mission.

Dynamic loading events that occur throughout various portions of the flight include steady-state acceleration, transient low frequency acceleration, acoustic impingement, random vibration, and pyrotechnic shock events.

4.1. Steady State and Transient Acceleration Loads

Design limit load factors due to the combined effects of steady state and low frequency transient accelerations are largely governed by payload characteristics. A mission-specific Coupled Loads Analysis (CLA) will be performed, with customer provided finite element models of the payload, in order to provide precise load predictions. Results will be referenced in the mission specific ICD. For preliminary design purposes, NGIS can provide initial Center-of-Gravity (CG) netloads given a payload's mass properties, CG location and bending frequencies.

4.1.1. Transient Loads

Transient events account for approximately 90% of the total space vehicle loads with the remainder due to steady state events. Transient loads are highly dependent on SV mass, CG, natural frequencies, and moments of inertia as well as the chosen separation system and Payload Attach Fitting (PAF). All of these were varied to develop a range of transient lateral accelerations at the typical dominant transient event and are shown as a function of payload mass in Figure 4.1.1-1 for Minotaur IV and Figure 4.1.1-2 for Minotaur IV+, V, VI, and VI+. These graphs cover a wide range of parameters whereas most spacecraft/payloads will typically have lateral accelerations below 3.5 G's.

Preliminary and final CLAs will be performed for each Minotaur mission where the payload finite element model is coupled to the vehicle model. Forcing functions have been developed for all significant flight events

and load cases. Results from the CLA are reported in the Acceleration Transformation Matrix (ATM) and Load Transformation Matrix (LTM) as requested by the payload provider. A payload isolation system is available as a non-standard option and is described in Section 8.10. This system has been demonstrated to significantly reduce transient dynamic loads that occur during flight.

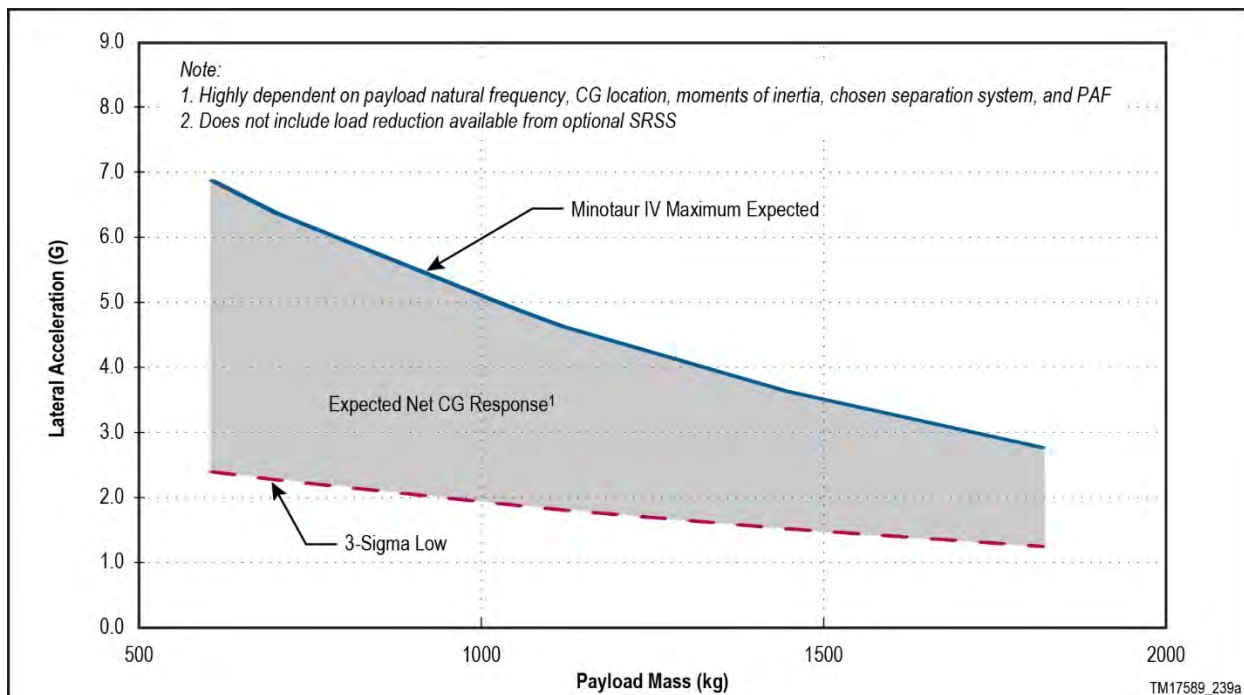

Figure 4.1.1-1. Payload CG Net Transient Lateral Acceleration (Minotaur IV)

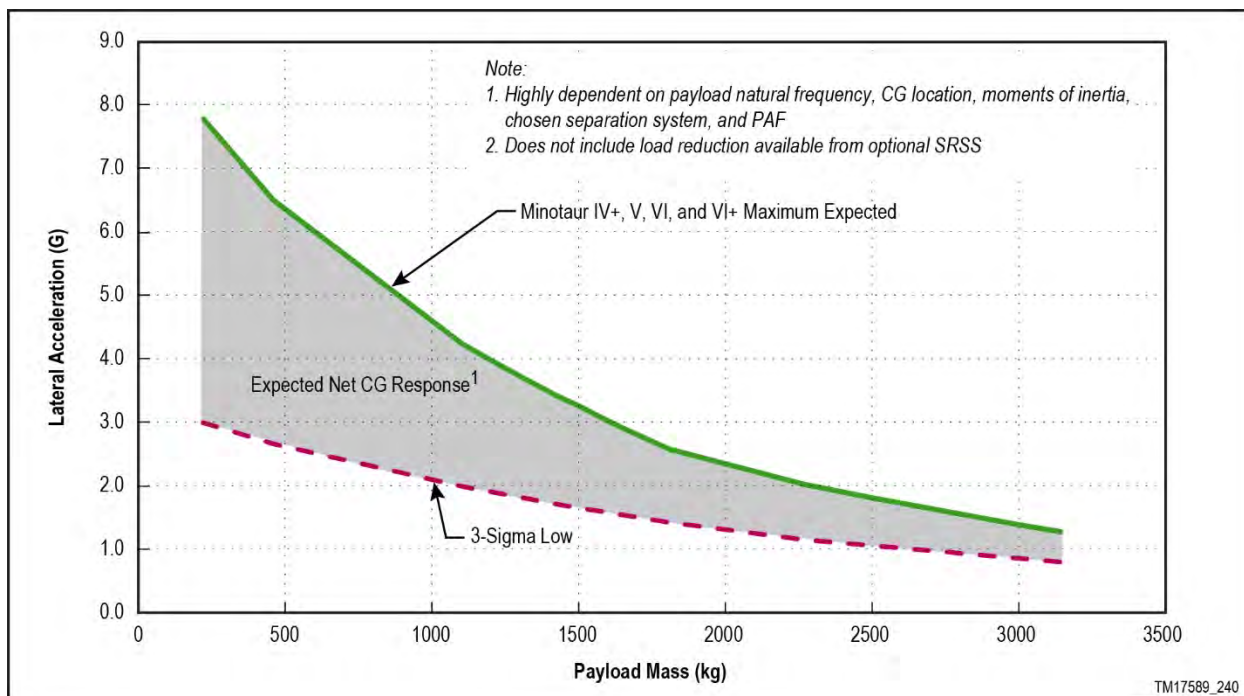

Figure 4.1.1-2. Payload CG Net Transient Lateral Acceleration (Minotaur IV+, V, VI, and VI+)

4.1.2. Steady-State Acceleration

Steady-state vehicle accelerations are determined from the vehicle rigid body analysis. Drag, wind and motor thrust are applied to a vehicle model. A Monte-Carlo analysis is performed to determine variations in vehicle acceleration due to changes in winds, motor performance and aerodynamics. The steady-state accelerations are added to transient accelerations from the CLA to determine the maximum expected payload acceleration. Maximum steady state accelerations are dependent on the payload mass enhancements chosen and vehicle configuration. Figure 4.1.2-1 depicts the maximum steady state axial acceleration as a function of payload mass. Lateral steady state accelerations are typically below 0.5 G's.

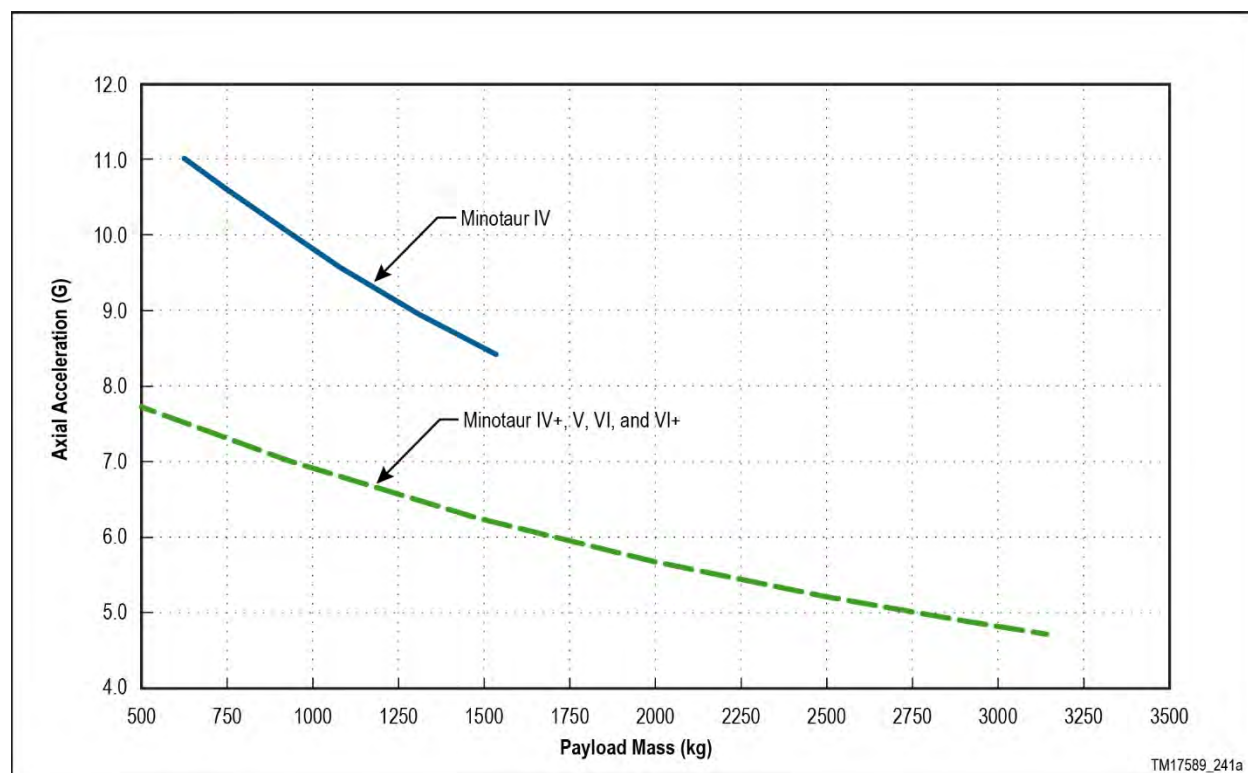

Figure 4.1.2-1. Minotaur IV Family Maximum Axial Acceleration as a Function of Payload Mass

4.2. Payload Vibration Environment

The Minotaur payload vibration environments are low frequency random and sinusoidal vibrations created by the solid rocket motor combustion processes and transmitted through the launch vehicle structure. Additionally, higher frequency aeroacoustics energy is created by air flow over the surface of the vehicle. Some of this aeroacoustic energy is transmitted via the launch vehicle structure to the payload. The majority of the aeroacoustic energy is transmitted to the payload directly as acoustic energy through the fairing.

4.2.1. Random Vibration

Payload random vibration is produced from two sources. The first is structural born from the launch vehicle produced from motor burn and acoustics acting on the launch vehicle. This tends to be, low frequency, less than 250 Hz, and can be simulated using a base driven test. The second source is from acoustics acting on the spacecraft. This tends to be high frequency, greater than 250 Hz, and is not easily simulated using a base driven test. The response at the LV/SV interface is strongly dependent on the unique spacecraft dynamics, including its response to the acoustic field. Therefore, structural born random vibration environments are only defined up to 250 Hz and are shown in Figure 4.2.1-1.

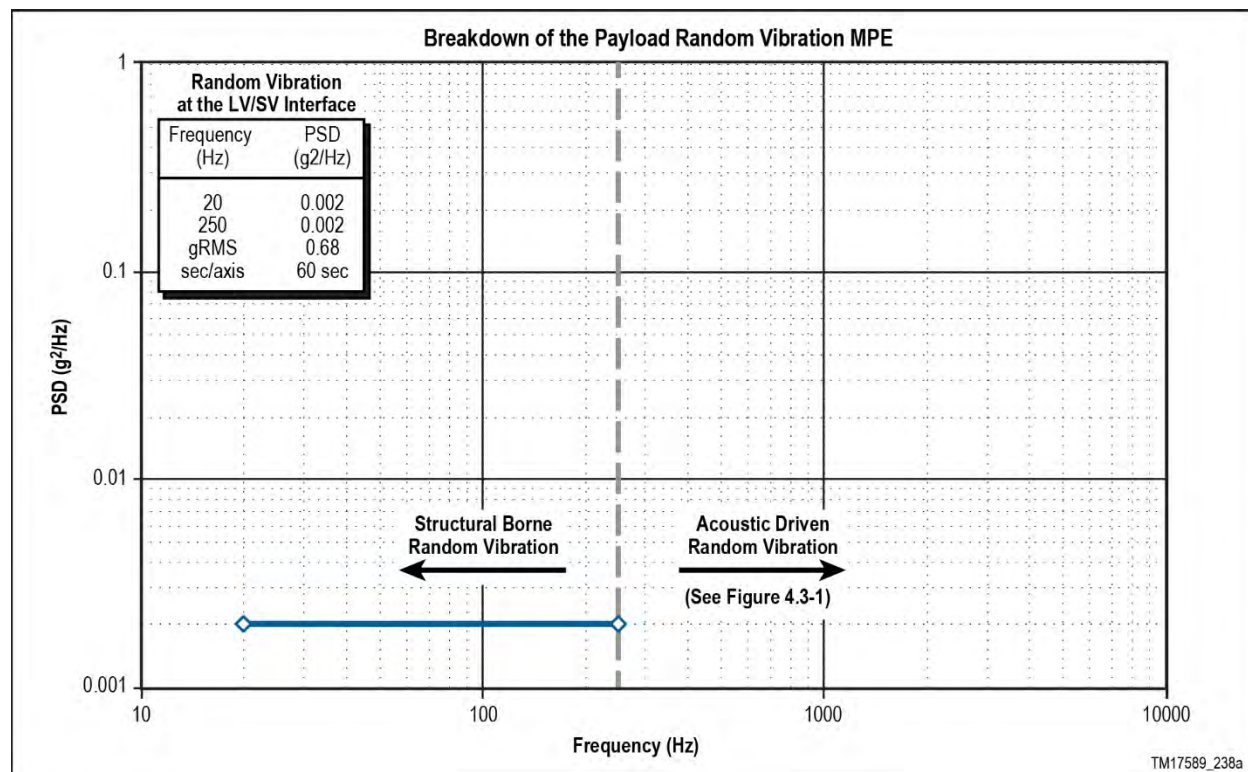

Figure 4.2.1-1. Minotaur IV Family Payload Random Vibration Environment

NGIS recommends that the payload be subject to acoustic testing per Section 4.3, which will envelope the high frequency (>250 Hz) structural born random vibration, and that the payload be designed/qualified to meet the CLA results which envelope the low frequency (<250 Hz) structural born random vibration.

4.2.2. Sine Vibration

There are only two sources of sine vibration excitation on the Minotaur vehicle and they are defined at the LV/SV interface as shown in Figures 4.2.2-1 and 4.2.2-2.

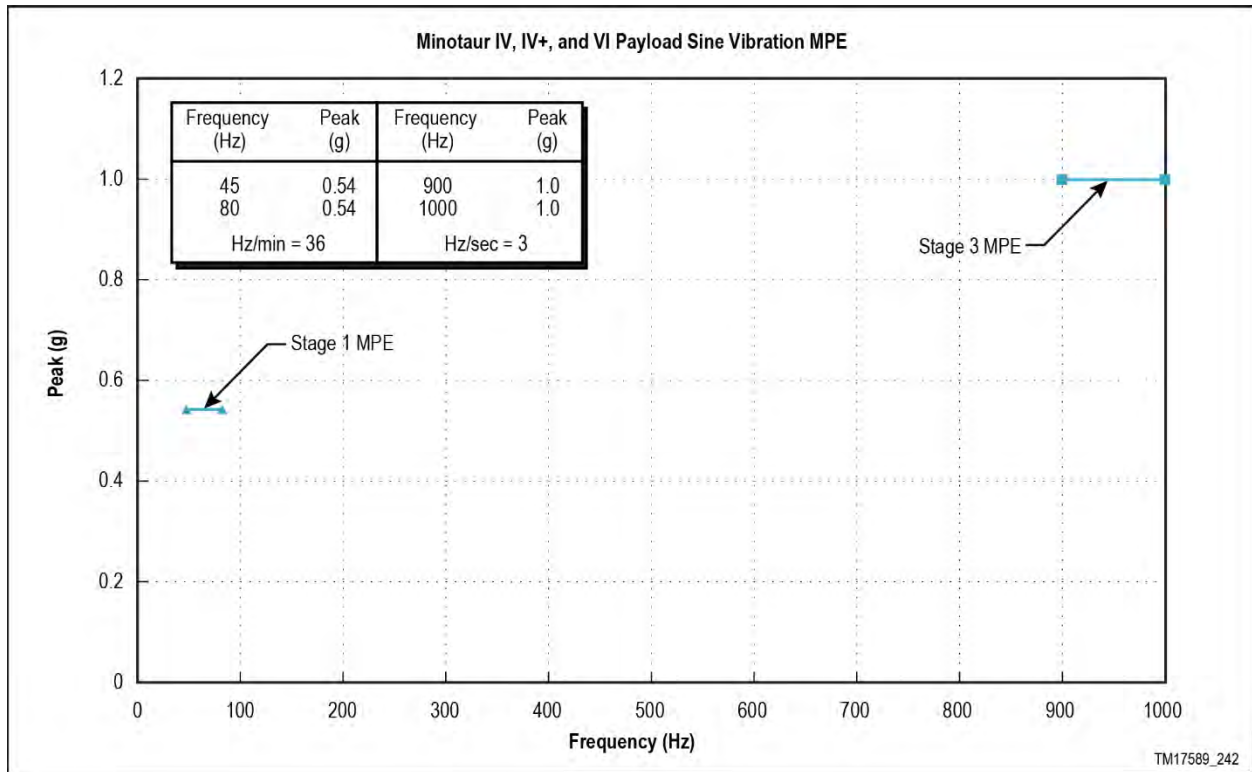

Figure 4.2.2-1. Minotaur IV, IV+, and VI Payload Sine Vibration MPE Levels

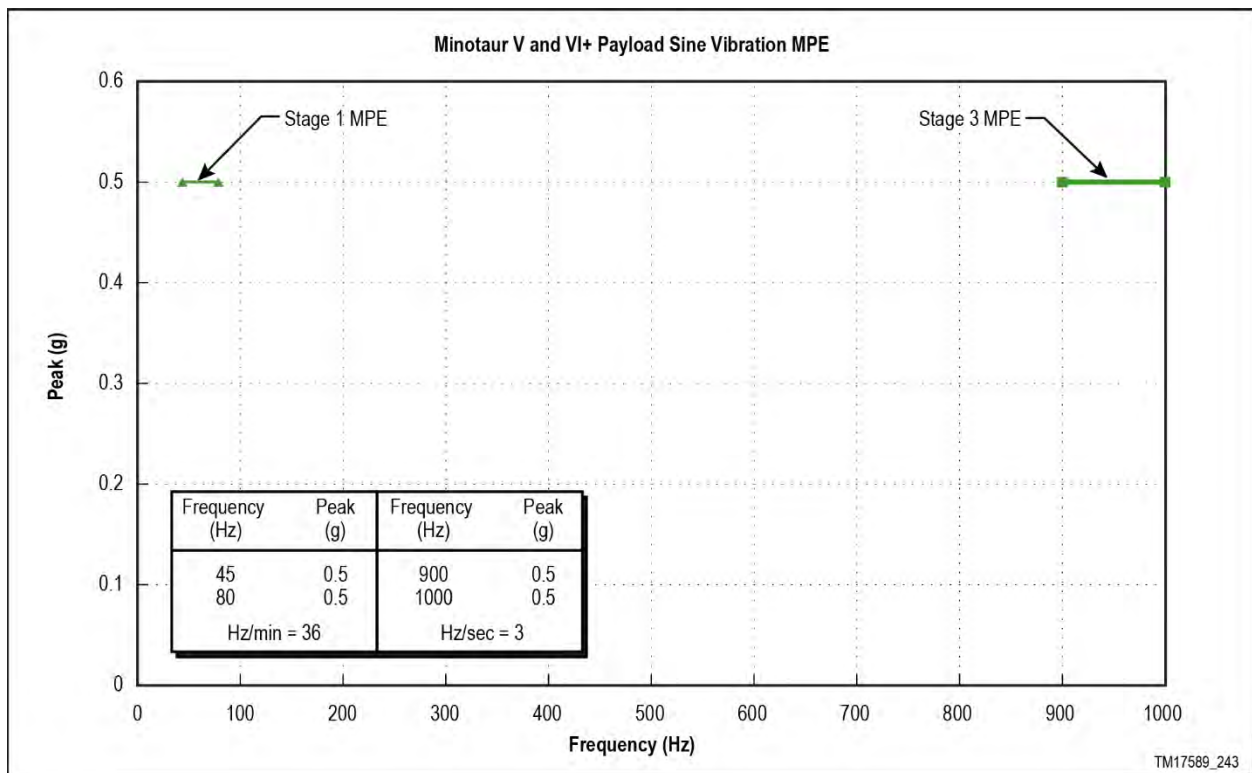

Figure 4.2.2-2. Minotaur V and VI+ Payload Sine Vibration MPE Levels

4.3. Payload Acoustic Environment

The acoustic environments to which the spacecraft will be exposed have been defined based on measured acoustic data from previous flights which utilized the Peacekeeper Stage 1 motor and 92 in. fairing. The data was adjusted to account for differences in vehicle trajectories. The resulting acoustic level, which also includes the damping of the acoustic blankets, is shown in Figure 4.3-1. Acoustic environments for the optional 110" fairing are enveloped by these levels.

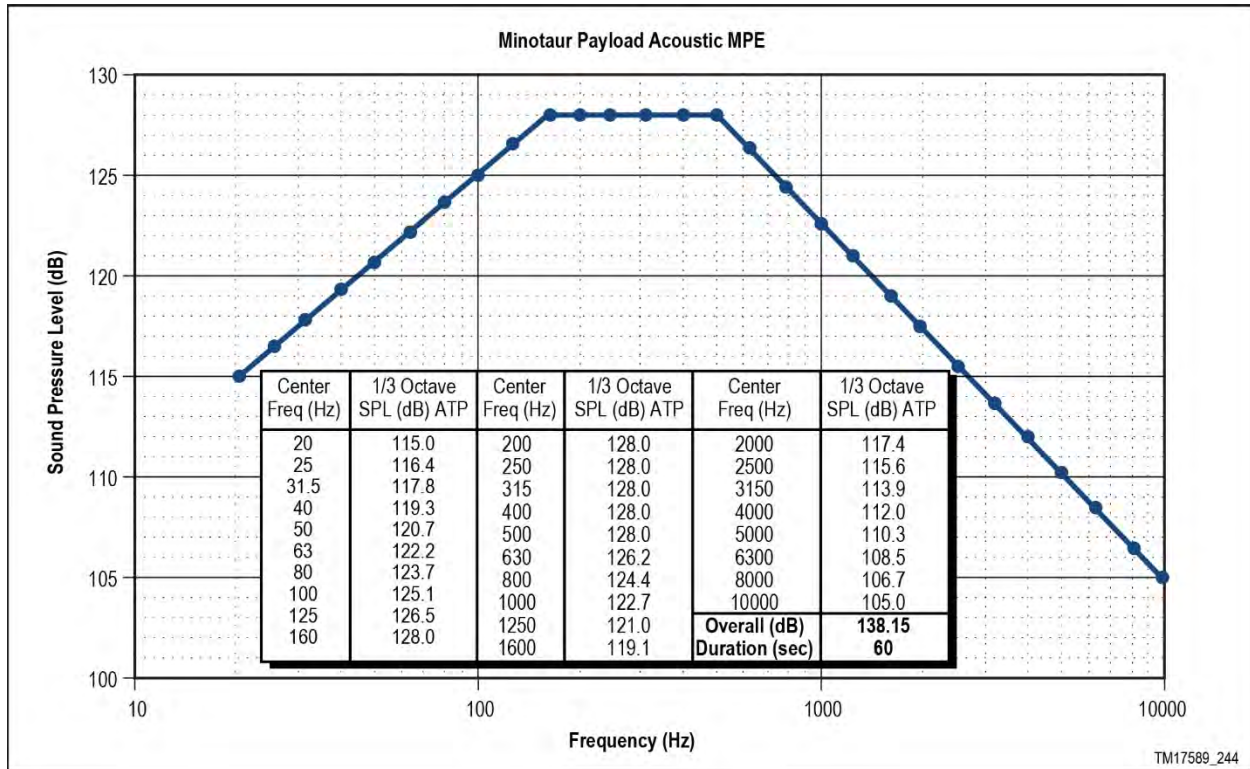

Figure 4.3-1. Minotaur IV Payload Acoustic Maximum Predicted Environment (MPE) with 1/3 Octave Breakpoints

4.4. Payload Shock Environment

The maximum shock response spectrum at the base of the payload from the launch vehicle will not exceed the flight limit levels (LV to Payload) in Figure 4.4-1 (Minotaur IV/IV+/VI) and Figure 4.4-2 (Minotaur V/VI+). For missions that utilize an NGIS-supplied separation system, the maximum expected shock (LV to Payload) will be the level shown for the chosen separation system. For missions that do not utilize an NGIS-supplied separation system, the maximum expected shock (LV to Payload) is provided and denoted as "Fairing Jettison Shock at Payload I/F".

For all missions, the shock response spectrum at the base of the payload from payload events should not exceed the levels in Figure 4.4-3 (Payload to LV). Shock above this level could require requalification of launch vehicle components.

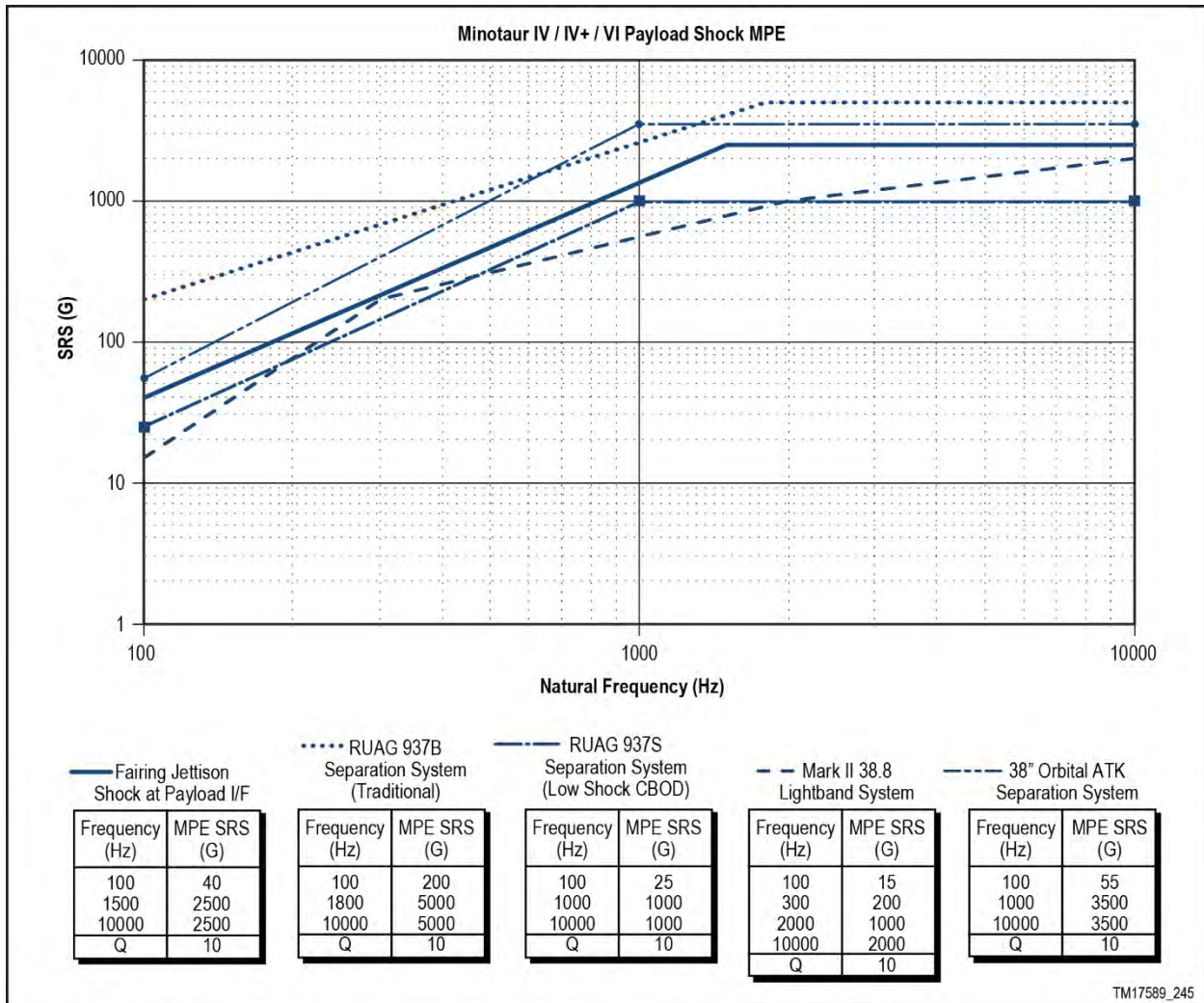

Figure 4.4-1. Minotaur IV Family Payload Shock Maximum Predicted Environment (MPE) – Launch Vehicle to Payload

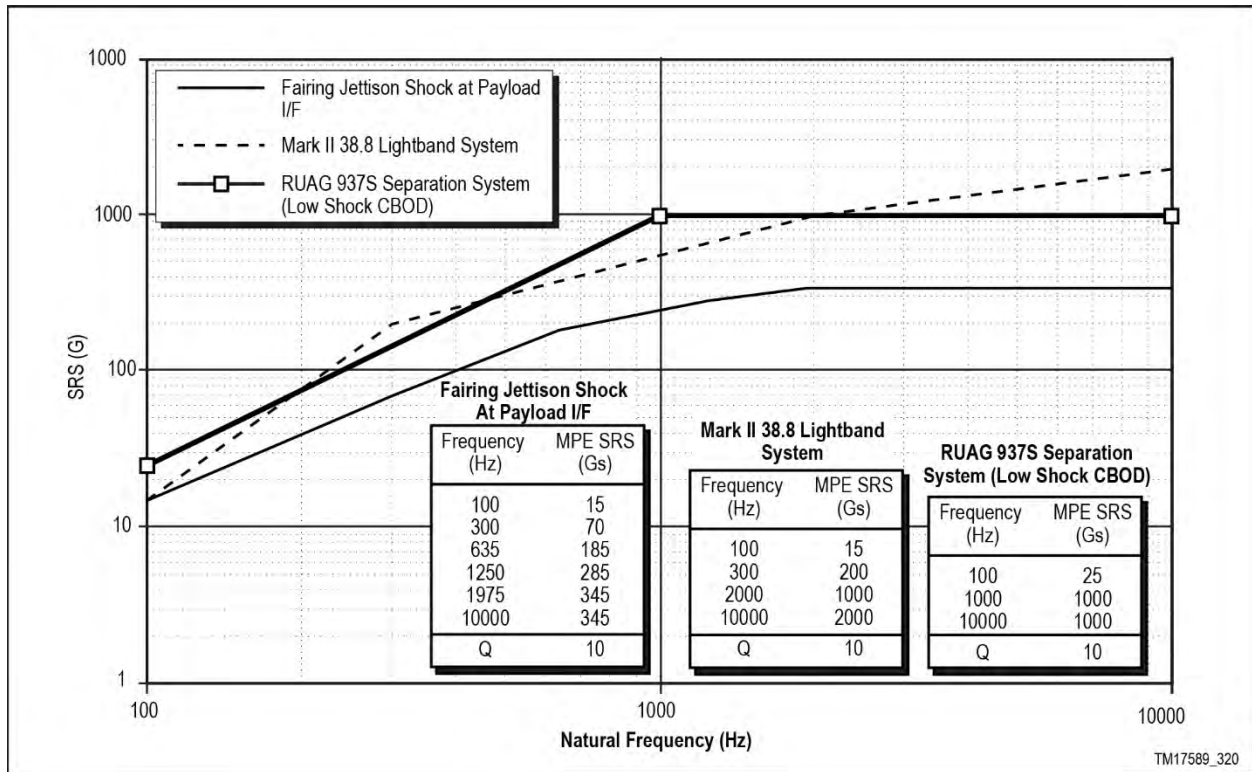

Figure 4.4-2. Minotaur V/VI+ Payload Shock MPE – Launch Vehicle to Payload

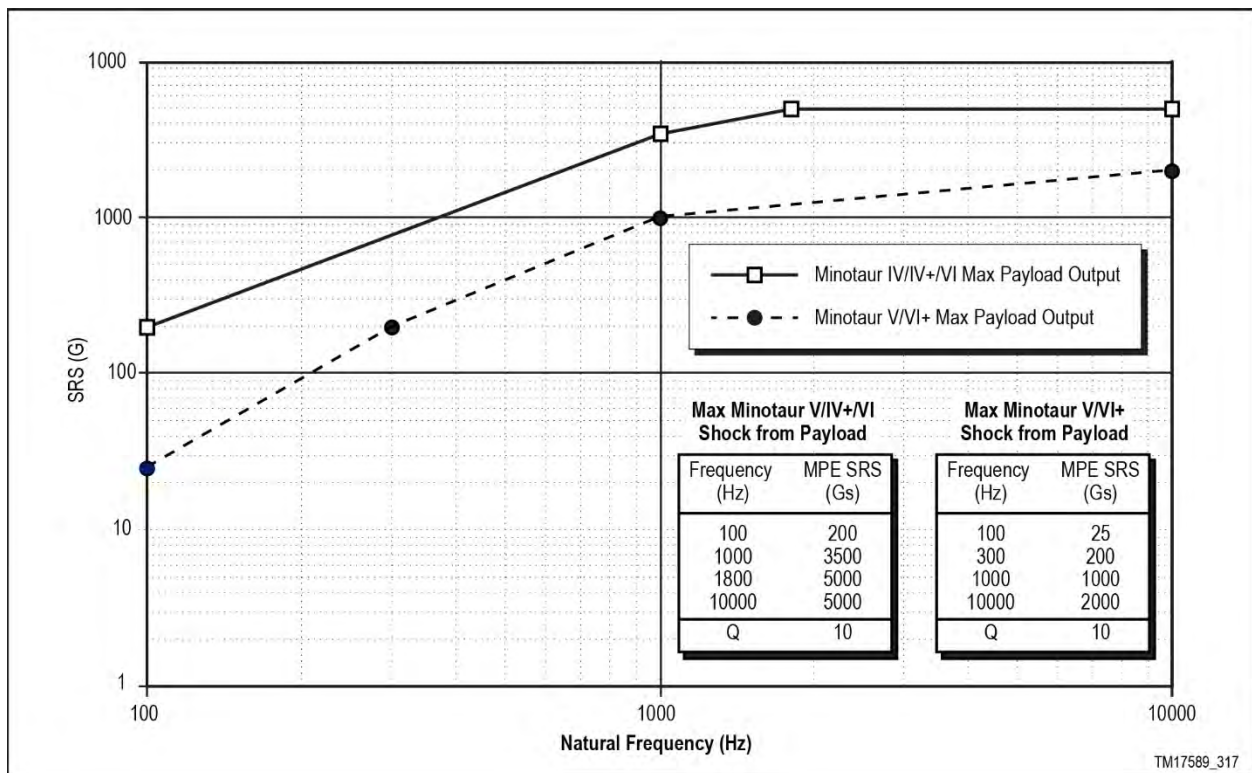

Figure 4.4-3. Maximum Shock Environment - Payload to Launch Vehicle

4.5. Payload Structural Integrity and Environments Verification

The spacecraft must possess sufficient structural characteristics to survive ground handling and flight load conditions with margin in a manner that assures both safety and mission success.

Sufficient payload testing and/or analysis must be performed to show adequate margin to the environments and loads specified in Sections 4.1 through 4.4. The payload design should comply with the testing and design factors of safety as found in MIL-HNBK-340A (ref. MIL-STD-1540B) and NASA GEVS Rev. A June '96. The payload organization must provide NGIS with verification via analyses and tests that the payload can survive these environments prior to payload arrival at the integration facility.

4.6. Thermal and Humidity Environments

The thermal and humidity environment to which the payload may be exposed during vehicle processing and pad operations are defined in the following sections.

4.6.1. Ground Operations

Upon encapsulation within the fairing and for the remainder of ground operations, the payload environment will be maintained by a Heating, Ventilation and Air Conditioning (HVAC) Environmental Control Unit (ECU). The HVAC provides conditioned air to the payload in the Payload Processing Facility (PPF) after fairing integration. HVAC is provided during transport, lifting operations, and at the launch pad. The conditioned air enters the fairing volume at a location forward of the payload, exits aft of the payload and is provided up to the moment of launch. A diffuser is designed into the air conditioning inlet to reduce impingement velocities on the payload. Class 10 K (ISO 7) can be provided inside a clean room and at the payload fairing HVAC inlet on a mission specific basis as an enhanced option.

Fairing inlet conditions are selected by the customer, and are bounded as follows:

- a. Dry Bulb Temperature: 13 to 29 °C (55 to 85 °F) controllable to ± 5 °C (± 10 °F) of setpoint.
- b. Temperature environment lower limit is 55 °F (12.8 °C) due to the upper stage motor limits.
- c. Standard Setpoint = 18.3 °C (65 °F)
- d. Dew Point Temperature: 3 to 17 °C (38 to 62 °F)
- e. Relative Humidity: determined by drybulb and dew point temperature selections and generally controlled to within $\pm 15\%$. Relative humidity is bound by the psychrometric chart and will be controlled such that the dew point within the fairing is never reached.
- f. Nominal Flow: 11.3 m³/min (400 cfm)

A diagram of the HVAC system is shown in Figure 4.6.1-1.

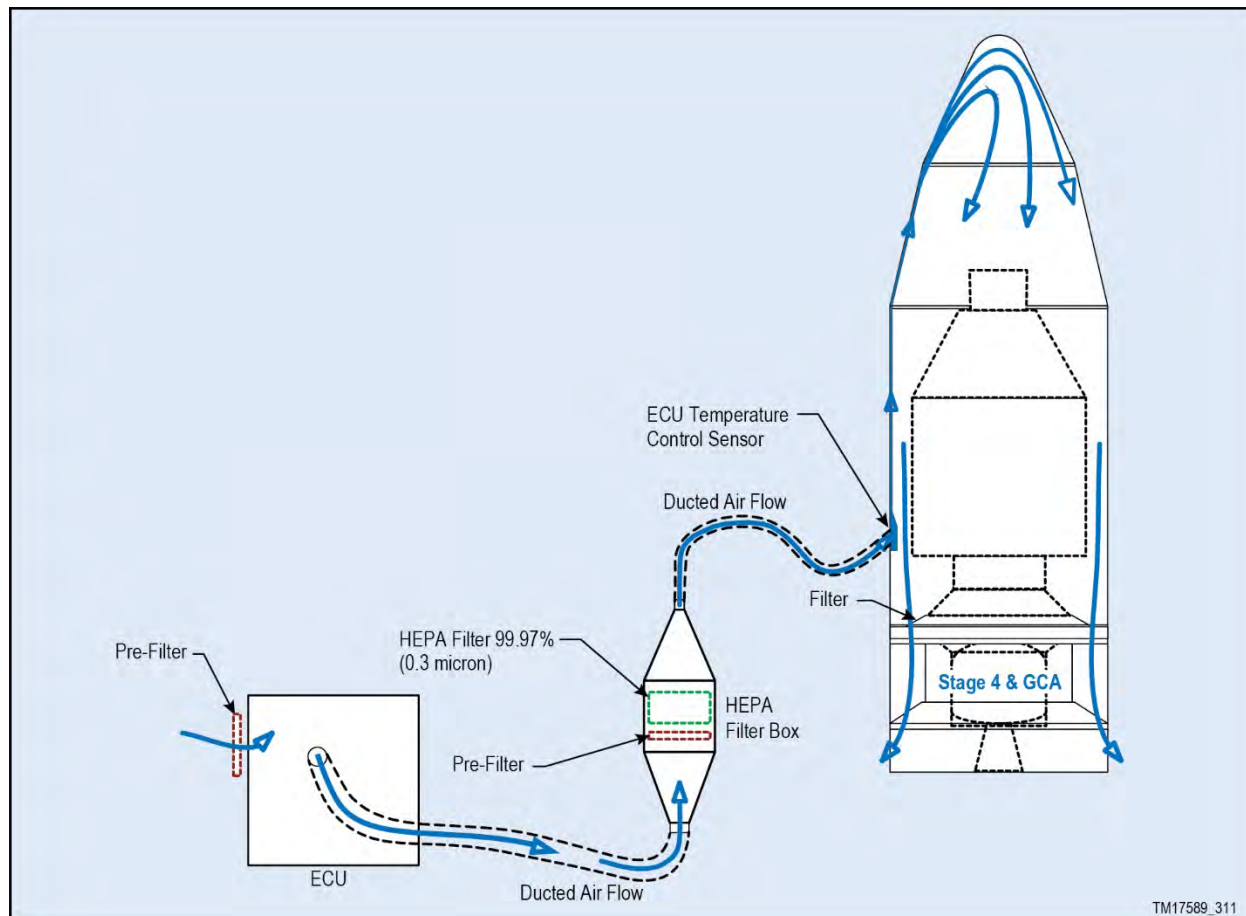

Figure 4.6.1-1. Minotaur IV HVAC System Provides Conditioned Air to the Payload

4.6.2. Powered Flight

The maximum fairing inside wall temperature will be maintained at less than 93 °C (200 °F), with an emissivity of 0.92 in the region of the payload. However, the payload will see significantly lower temperatures and emissivity due to fairing acoustic blankets. This temperature limit envelopes the maximum temperature of any component inside the payload fairing with a view factor to the payload.

The fairing peak vent rate is typically less than 1.0 psi/sec, as shown in Figure 4.6.2-1. Fairing deployment will be initiated at a time in flight that the maximum dynamic pressure is less than 0.01 psf or the maximum free molecular heating rate is less than 1136 W/m² (0.1 BTU/ft²/sec), as required by the payload.

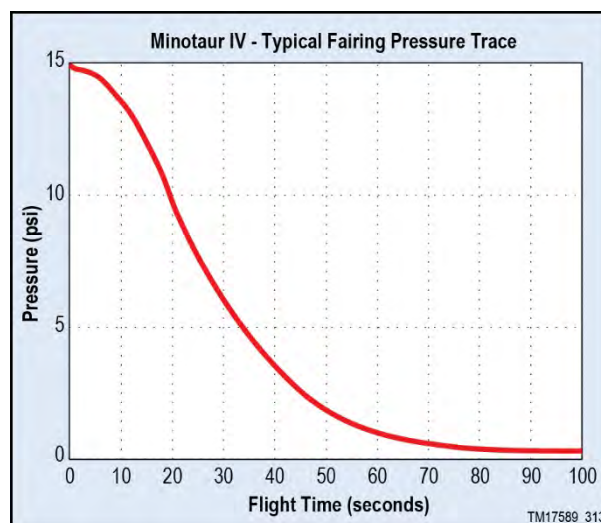

Figure 4.6.2-1. Typical Minotaur IV Fairing Pressure Profile

4.6.3. Nitrogen Purge (Non-Standard Service)

If required for spot cooling or purging of a payload component, NGIS will provide GN2 flow to localized regions in the fairing as a non-standard service. This option is discussed in more detail in Section 8.3.

4.7. Payload Contamination Control

All payload integration procedures, and NGIS' contamination control program have been designed to minimize the payload's exposure to contamination from the time the payload arrives at the payload processing facility through orbit insertion and separation. The payload is fully encapsulated within the fairing at the payload processing facility, assuring the payload environment stays clean in a Class 100,000 environment. Launch vehicle assemblies that affect cleanliness within the encapsulated payload volume include the fairing and the payload cone assembly. These assemblies are cleaned such that there is no particulate or non-particulate matter visible to the normal unaided eye when inspected from 2 to 4 feet under 50 ft-candle incident light (Visibly Clean Level II). After encapsulation, the fairing envelope is either sealed or maintained with a positive pressure, Class 100,000 (ISO 8) continuous purge of conditioned air.

If required, the payload can be provided with enhanced contamination control as an option, providing a Class 10,000 (ISO 7) environment, low outgassing, and Visibly Clean Plus Ultraviolet cleanliness. With the enhanced contamination control option, the NGIS-supplied elements will be cleaned and controlled to support a Class 10,000 clean room environment, as defined in ISO 14644-1 clean room standards (ISO 7). This includes limiting volatile hydrocarbons to maintain hydrocarbon content at less than 15 ppm.

Also with the enhanced contamination control option, the ECU continuously purges the fairing volume with clean filtered air and maintains humidity between 30 to 60 percent. NGIS' ECU incorporates a HEPA filter unit to provide ISO 7 (Class 10,000) air. NGIS monitors the supply air for particulate matter via a probe installed upstream of the fairing inlet duct prior to connecting the air source to the payload fairing.

4.8. Payload Electromagnetic Environment

The payload Electromagnetic Environment (EME) results from two categories of emitters: Minotaur onboard antennas and Range radar. All power, control and signal lines inside the payload fairing are shielded and properly terminated to minimize the potential for Electromagnetic Interference (EMI). The Minotaur payload fairing is Radio Frequency (RF) opaque, which shields the payload from external RF signals while the payload is encapsulated.

Table 4.8-1 lists the frequencies and maximum radiated signal levels from vehicle antennas that are located near the payload during ground operations and powered flight. The specific EME experienced by the payload during ground processing at the PPF and the launch site will depend somewhat on the specific facilities that are utilized as well as operational details. However, typically the field strengths experienced by the payload during ground processing with the fairing in place are controlled procedurally and will be less than 2 V/m from continuous sources and less than 10 V/m from pulse sources. The highest EME during powered flight is created by the C-Band transponder transmission, which results in peak levels at the payload interface plane of 25.40 V/m at 5765 MHz. Range transmitters are typically controlled to provide a field strength of 10 V/m or less inside the fairing. This EME should be compared to the payload's RF susceptibility levels (MIL-STD-461, RS03) to define margin.

Table 4.8-1. Minotaur IV Launch Vehicle RF Emitters and Receivers

SOURCE	1	2	3	4	5	6	7	8
Function	Command Destruct	Tracking Transponder	Tracking Transponder	Launch Vehicle	Enhanced Instrumentation Telemetry (Optional)	GPB A	GPB B	GPB
Receive/Transmit	Receive	Transmit	Receive	Transmit	Transmit	Transmit	Transmit	Receive
Band	UHF	C-Band	C-Band	S-Band	S-Band	S-Band	S-Band	L-Band (L1/L2)
Frequency (MHz)	421	5765	5690	2240.5	2285.5	2260.5	2270.5	1575.42 / 1227.6
Bandwidth	N/A	14 MHz	14 MHz	1.78 MHz	1.78 MHz	256 kHz	256 kHz	20.46 MHz (P(Y) Code)
Power Output	N/A	400 W (peak)	N/A	10 W	10 W	5 W	5 W	N/A
Sensitivity	-107 dBm	-70 dBm	-70 dBm	N/A	N/A	N/A	N/A	-123 dBm
Modulation	Tone	Pulse Code	Pulse Code	PCM/FM	PCM/FM	PCM/FM	PCM/FM	Spread Spectrum QPSK
Field Strength at Fwd Edge of the Payload Adapter Cone	N/A	1.99 V/m avg (25.40 V/m per 0.5µs pulse)	N/A	<11 V/m	<11 V/m	<6 V/m	<6 V/m	N/A

5. PAYLOAD INTERFACES

This section describes the available mechanical, electrical and Launch Support Equipment (LSE) interfaces between the Minotaur launch vehicle and the payload.

5.1. Payload Fairing

5.1.1. 92" Standard Minotaur Fairing

NGIS' flight proven 92-inch diameter payload fairing is used to encapsulate the payload, provide protection and contamination control during ground handling, integration operations and flight. The fairing is a bi-conic design made of graphite/epoxy face sheets with aluminum honeycomb core. The two halves of the fairing are structurally joined along their longitudinal interface using NGIS' low contamination frangible joint system. An additional circumferential frangible joint at the base of the fairing supports the fairing loads. At separation, a gas pressurization system is activated to pressurize the fairing deployment thrusters. The fairing halves then rotate about external hinges that control the fairing deployment to ensure that payload and launch vehicle clearances are maintained. All elements of the deployment system have been demonstrated through numerous ground tests and flights.

5.1.1.1. 92" Fairing Payload Dynamic Design Envelope

The fairing drawing in Figure 5.1.1.1-1 shows the maximum dynamic envelope available in the standard MIV configuration for the payload during powered flight. The dynamic envelope shown accounts for fairing and vehicle structural deflections only. The payload contractor must consider deflections due to spacecraft design and manufacturing tolerance stack-up within the dynamic envelope. Proposed payload dynamic envelope violations must be approved by NGIS via the ICD.

No part of the payload may extend aft of the payload interface plane without specific NGIS approval. Incursions below the payload interface plane may be approved on a case-by-case basis after additional verification that the incursions do not cause any detrimental effects. Vertices for payload deflection must be given with the Finite Element Model to evaluate payload dynamic deflection with the Coupled Loads Analysis (CLA). The payload contractor should assume that the interface plane is rigid; NGIS has accounted for deflections of the interface plane. The CLA will provide final verification that the payload does not violate the dynamic envelope.

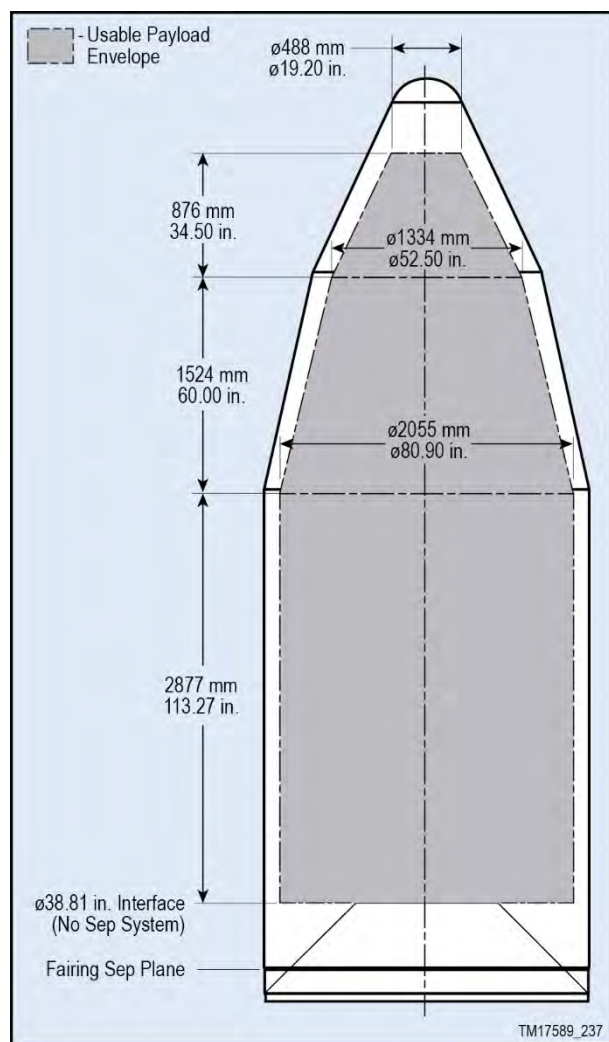

Figure 5.1.1.1-1. Dynamic Envelope for Standard 92" Fairing with Standard 38" PAF

5.1.2. Optional 110" Fairing

A larger 110" diameter fairing design is available as an enhancement to accommodate payloads larger than those that can be fit in the standard 92" diameter fairing. The larger fairing is primarily intended for use by Minotaur VI and VI+ payloads, with limited applications available on other Minotaur configurations. Flying the 110" fairing will result in approximately 200 kg performance impact and reduced launch availability. The fairing, composite materials, structural testing, separation and deployment systems are similar to those of the heritage 92" fairing. The only appreciable change to the deployment system is the use of a new thruster bracket that attaches to the boat-tail portion of the aft end of the fairing. Deployment margin is actually improved for the 110" fairing vs. the standard fairing because the larger diameter of the 110" fairing draws the fairing mass radially outward and closer to the hinge pivot points.

Performance runs with the 110" fairing are included within Section 3.0.

5.1.2.1. 110" Fairing Payload Dynamic Design Envelope

Figure 5.1.2.1-1 shows the maximum dynamic envelope available in the larger 110" fairing for the payload during powered flight. The dynamic envelope shown accounts for fairing and vehicle structural deflections only. The payload contractor must consider deflections due to spacecraft design and manufacturing tolerance stack-up within the dynamic envelope. Proposed payload dynamic envelope violations must be approved by NGIS via the ICD.

No part of the payload may extend aft of the payload interface plane without specific NGIS approval. Incursions below the payload interface plane may be approved on a case-by-case basis after additional verification that the incursions do not cause any detrimental effects. Vertices for payload deflection must be given with the Finite Element Model to evaluate payload dynamic deflection with the Coupled Loads Analysis (CLA). The payload contractor should assume that the interface plane is rigid; NGIS has accounted for deflections of the interface plane. The CLA will provide final verification that the payload does not violate the dynamic envelope.

5.1.3. Payload Access Door

NGIS provides one 457 mm by 610 mm (18 in. by 24 in.) payload fairing access door to provide access to the payload after fairing mate. The door can be positioned according to payload requirements within the cylindrical section of the fairing, providing access to the payload without having to remove any portion of the fairing or break electrical connections. If necessary, the fairing access door may be placed within the lower conic section of the fairing, however the standard size is reduced to 356 mm by 559 mm

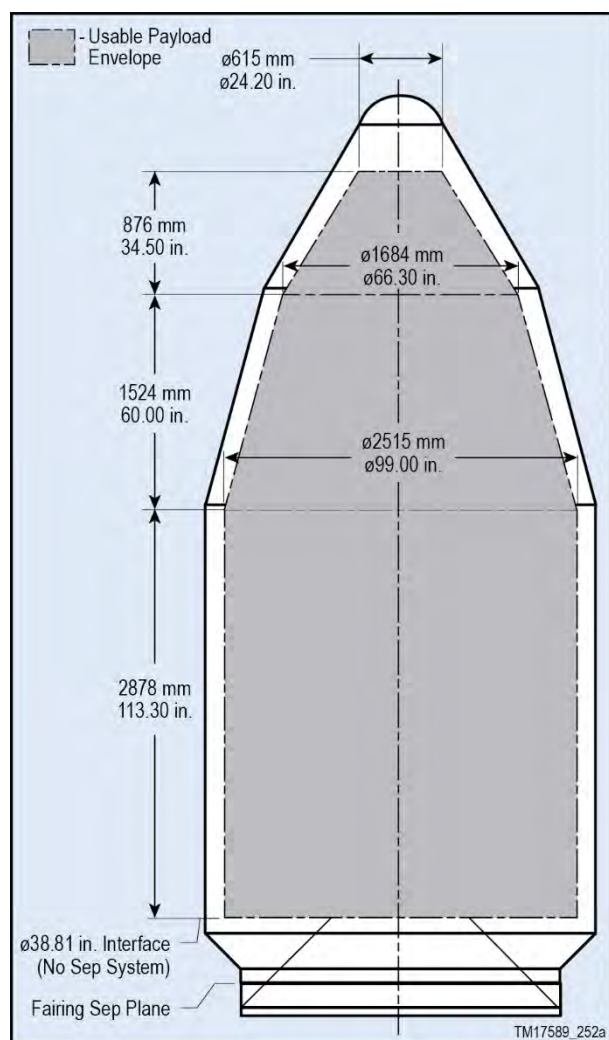

Figure 5.1.2.1-1. Dynamic Envelope for Optional 110" Fairing with Standard 38" PAF

(14 in. by 22 in.). The specific location is defined and controlled in the payload ICD. See Figure 5.1.3-1 for available Access Door locations. Additional access doors can readily be provided as an enhanced option (see Section 8.4).

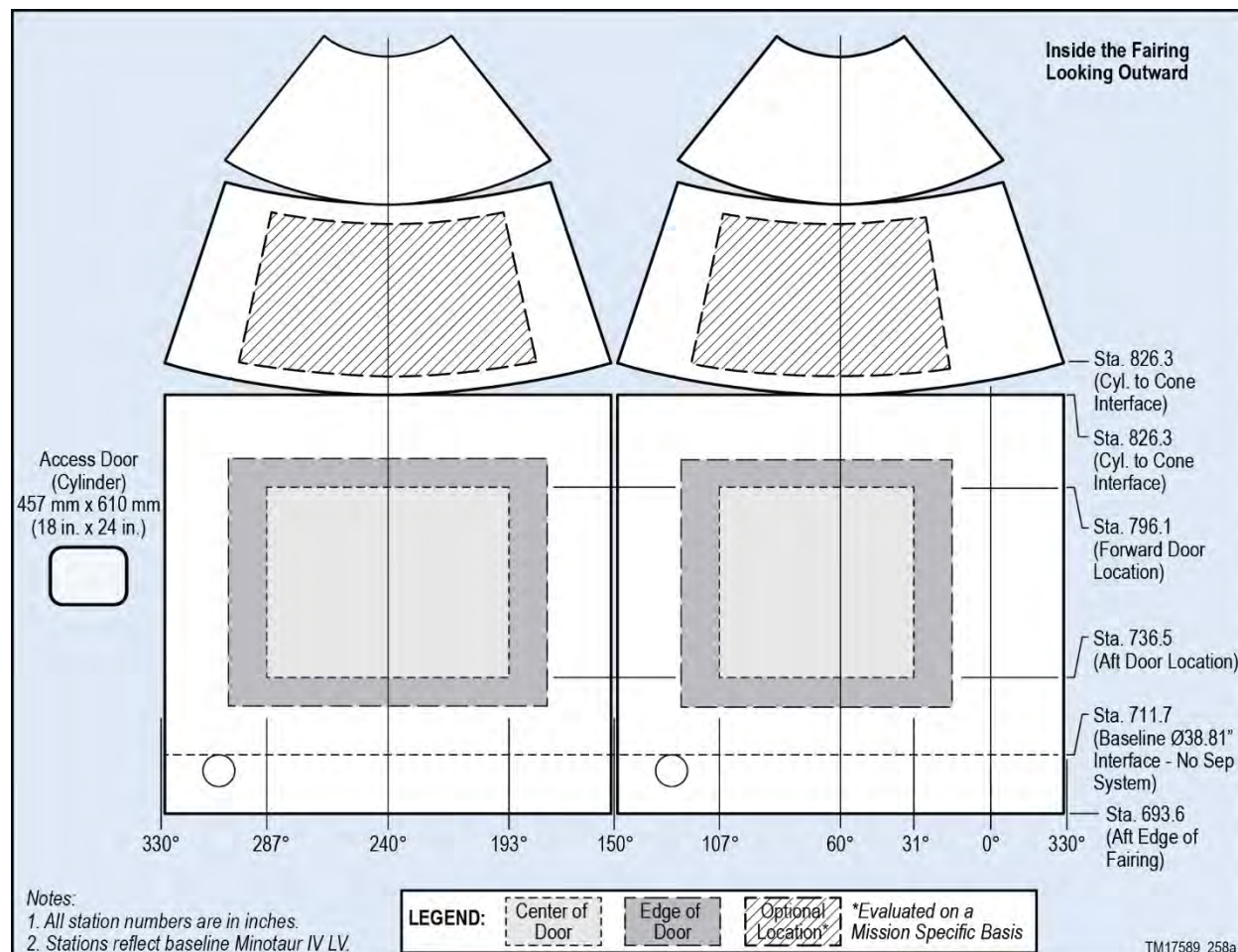

Figure 5.1.3-1. Available Fairing Access Door Locations

5.2. Payload Mechanical Interface and Separation System

Minotaur provides for a standard non-separating payload interface. NGIS will provide all flight hardware and integration services necessary to attach non-separating and separating payloads to the Minotaur launch vehicle. Payload ground handling equipment is typically the responsibility of the payload contractor. All attachment hardware, whether NGIS or customer provided, must contain locking features consisting of locking nuts, inserts or fasteners. Additional mechanical interface diameters and configurations can readily be provided as an enhanced option.

5.2.1. Minotaur Coordinate System

The Minotaur IV Launch Vehicle coordinate system is defined in Figure 5.2.1-1. For clocking references, degree marks are counterclockwise when forward looking aft. The positive X-axis is forward along the vehicle longitudinal centerline, the positive Z axis is along the 180 deg angular, and the positive Y axis is along the 90 deg angular station, and completes the orthogonal system. The origin of the LV coordinate system is centered at the Stage 1 nozzle exit plane of the LV and the vehicle centerline (X = 0.0 in., Y = 0.0 in., Z = 0.0 in.).

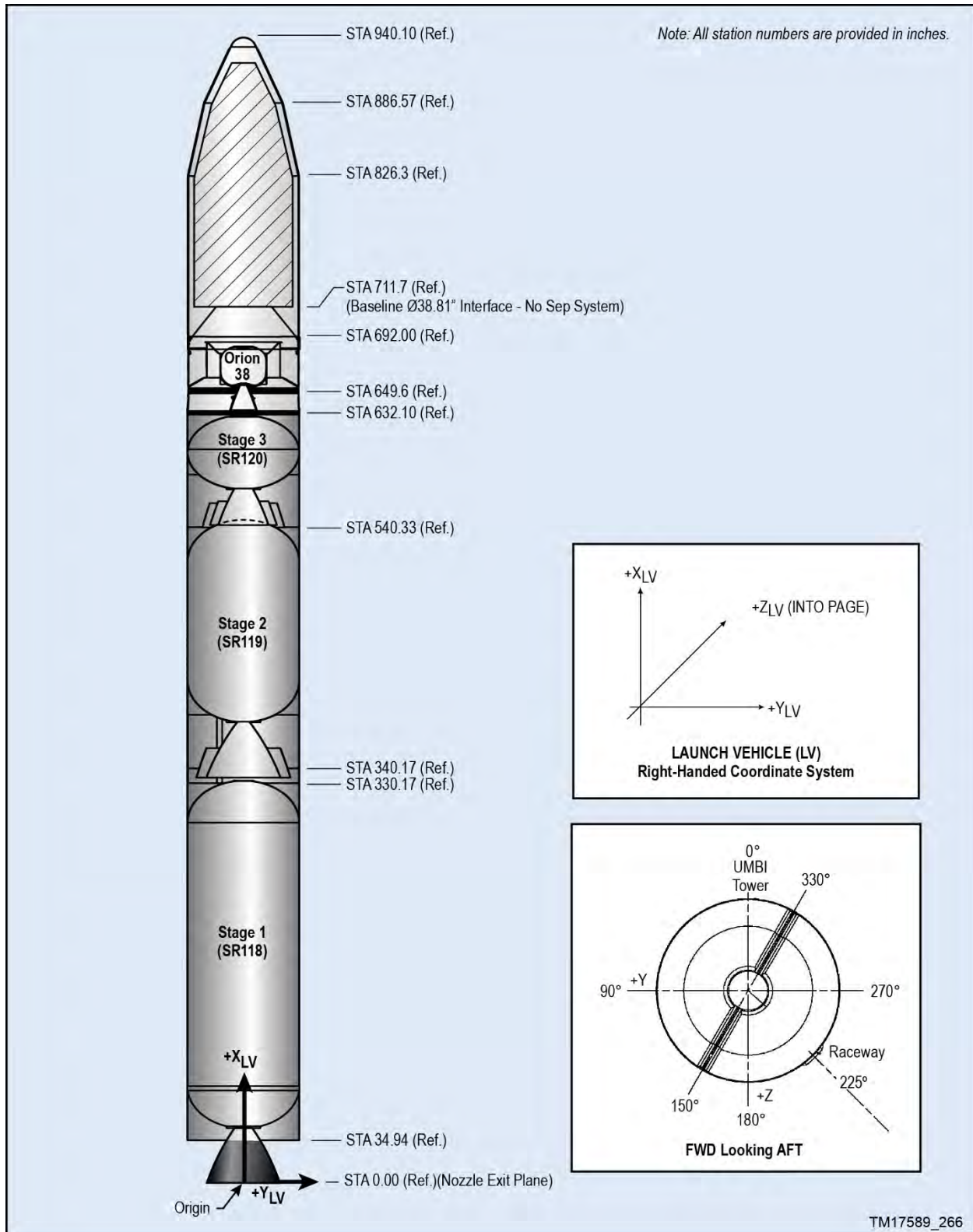

Figure 5.2.1-1. Minotaur IV Coordinate System

5.2.2. NGIS-Supplied Mechanical Interface Control Drawing

NGIS will provide a toleranced Mechanical Interface Control Drawing (MICD) to the payload contractor to allow accurate machining of the fastener holes. The NGIS provided MICD is the only approved documentation for drilling the payload interface.

5.2.3. Standard Non-Separating Mechanical Interface

NGIS' payload interface design provides a standard interface that will accommodate multiple payload configurations. The Minotaur IV baseline is for payloads to provide their own separation system or for payloads that will not separate. The standard interface is a 986 mm (38.81 in.) diameter bolted interface. A butt joint with 60 holes (0.281 in. diameter) designed for ¼ in. fasteners is the payload mounting surface as shown in Figure 5.2.3-1.

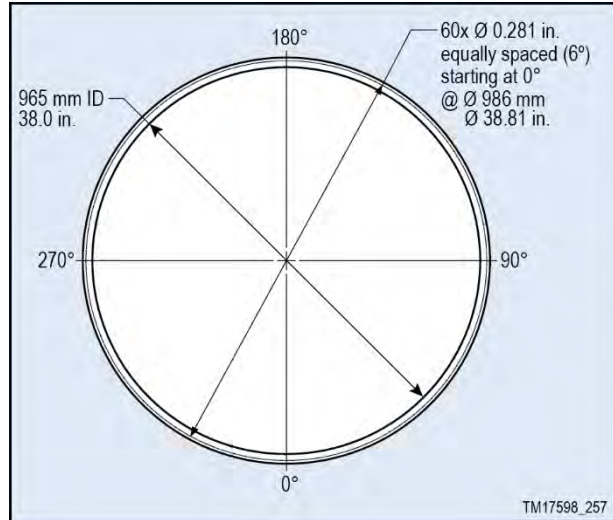

Figure 5.2.3-1. Standard, Non-separating 38.81'' Diameter Payload Mechanical Interface

5.2.4. Optional Mechanical Interfaces

Alternate or multiple payload configurations can be accommodated with the use of a variety of payload adapter fittings as listed in Table 5.2.4-1. The Minotaur IV family of Launch Vehicles allows flexibility in mounting patterns and configurations (Figure 5.2.4-1).

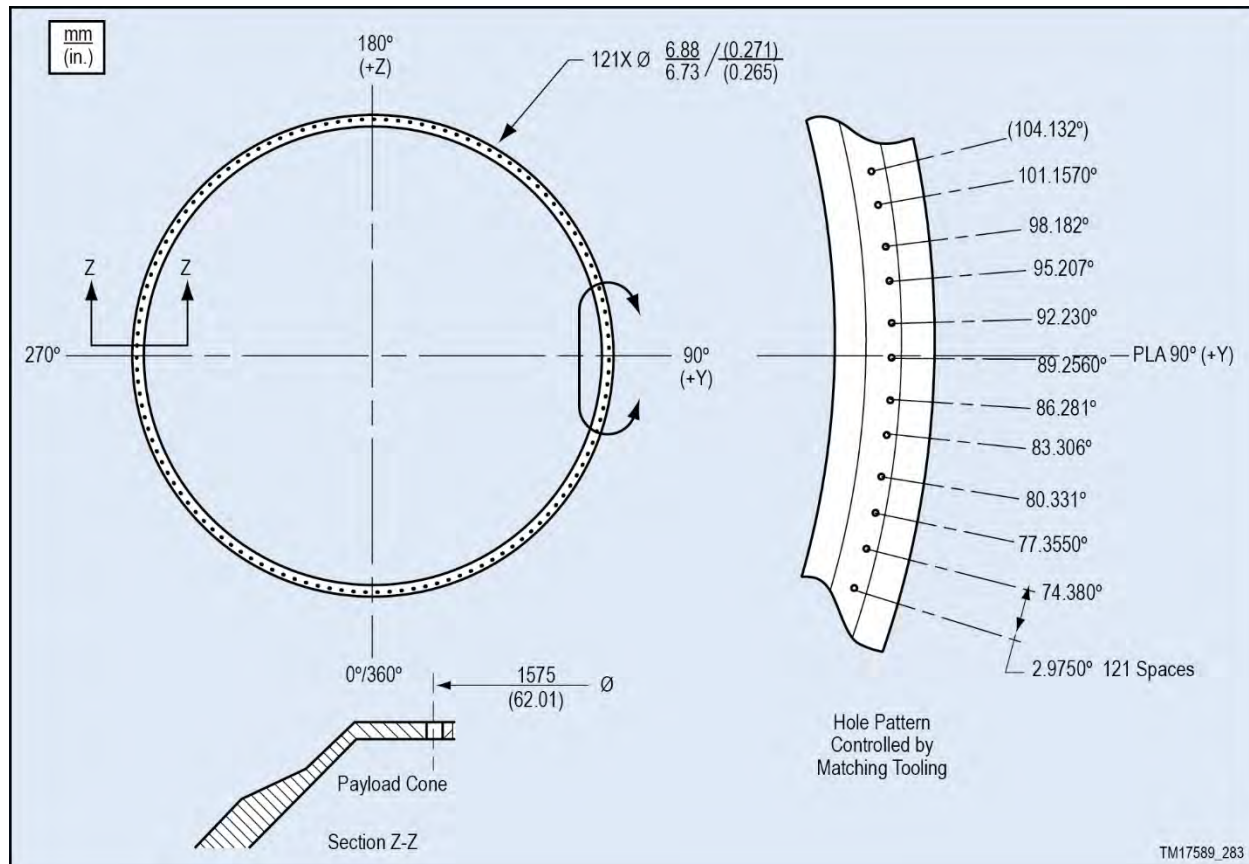



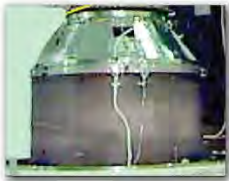





Figure 5.2.4-1. Optional, Non-Separating 62.01'' Diameter Payload Mechanical Interface

Table 5.2.4-1. Minotaur IV Payload Adapter Fitting Options

Payload Adapter Fitting	Description	Photo	Fairing Envelope	Mechanical Interface
38" Payload Cone (Standard Baseline Interface)	Baseline Minotaur IV Payload Attach Fitting (PAF) consists of a 38.81 in. diameter circular bolted interface. Payload mounting surface is a butt joint with 60 holes designed for 1/4" fasteners. Delta Mass from Baseline MIV: 0 kg (0 lbm)		Figure 5.1.1.1-1 (92" Fairing) Figure 5.1.2.1-1 (110" Fairing)	Figure 5.2.3-1
38" Two Piece Payload Cone	This PAF has the same mounting interface as the baseline Minotaur IV Payload Adapter Fitting (38.81 in. diameter circular bolted interface with 60 holes designed for 1/4 in. fasteners), however it is lower profile and moves the payload interface 203 mm (8 in.) aft providing additional fairing volume for use by the spacecraft. This configuration weighs more than the standard 38" payload cone. Delta Mass from Baseline MIV: +9.07 kg (+19.95 lbm)		Figure 5.2.4.1-1	Figure 5.2.3-1
62" Payload Cone	Evolved Expendable Launch Vehicle (EELV) Standard 62.01" diameter circular bolted Interface. Payload mounting surface is a butt joint with 121 holes designed for 1/4" fasteners. Delta Mass from Baseline MIV: -10.32 kg (-22.70 lbm)		Figure 5.2.4.1-2 (92" Fairing) Figure 5.2.4.1-3 (110" Fairing)	Figure 5.2.4-1
Dual Payload Adapter Fitting (DPAF)	The DPAF, based on flight proven design, supports delivery of two primary spacecraft to orbit. DPAF Maximum height is 2260 mm (89 in.). More details can be found in Section 5.2.4.2. Delta Mass from Baseline MIV: Varies depending on DPAF height. Two notional heights provided below: • 1445 mm (57 in.) DPAF: +97.7 kg (215 lbm) • 2159 mm (85 in.) DPAF: +118 kg (260 lbm)		Figure 5.2.4.2.1-1	Figure 5.2.3-1
Multi-Payload Adapter Fitting (MPAF)	The MPAF utilizes the flight proven multi-payload design from the STP-S26 mission. It supports up to eight individual payloads, including four EELV Secondary Payload Adapter (ESPA) class payloads. Alternate configurations are available as well to support fewer, but larger payloads. More details can be found in Section 5.2.4.2. Delta Mass from Baseline MIV: Contact Orbital ATK		Figure 5.2.4.2.2-1	Figure 5.2.4.2.2-2
Minotaur V Payload Attach Fitting (PAF)	The Minotaur V PAF is the interface between the LV Stage 5 and spacecraft. It is an anisogrid structure constructed of a graphite epoxy lattice winding that attaches to the forward flange of the Stage 5 forward cylinder. The PAF adapts to an 803 mm (31.6 in.) diameter spacecraft interface ring. Delta mass from Baseline Minotaur V/VI+: +3.85 kg (8.46 lbm)		Figure 5.2.4.2.3-2	Figure 5.2.4.2.3-3
Custom Mission Interfaces	Orbital ATK has other flight proven payload interface options such as the flight proven Payload Adapter Plate (shown to the right) flown on the HTV-2 Minotaur IV Lite missions. Other interface diameters can be accommodated as well, such as a 47 in. mounting interface required by some separation systems		Contact Orbital ATK	Contact Orbital ATK

TM17589_263

5.2.4.1. Payload Cone Interfaces

Several different payload cones can be provided to meet mission unique interface requirements. The base-line Minotaur IV 38.81 in. payload interface is described in Section 5.2.3. However, NGIS has other flight proven payload options. One option maintains the 986 mm (38.81 in.) interface, but increases the amount of fairing volume by using a two piece payload cone that moves the interface approximately 203 mm (8 in.) aft. This option adds 9 kg to the LV. NGIS can also provide other options, such as 1194 mm (47 in.) or 1575 mm (62 in.) interfaces required by some separation systems. These options are shown in Table 5.2.4-1 with corresponding fairing envelopes shown in Figures 5.2.4.1-1 through 5.2.4.1-3.

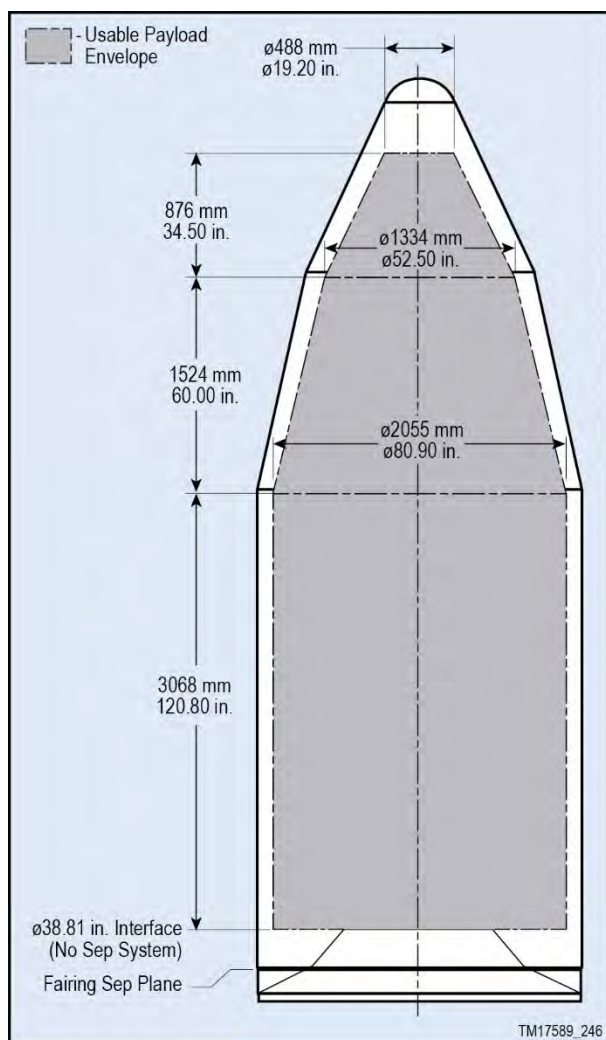

Figure 5.2.4.1-1. Dynamic Envelope for Standard 92'' Fairing with Optional 38'' 2-Piece Payload Cone

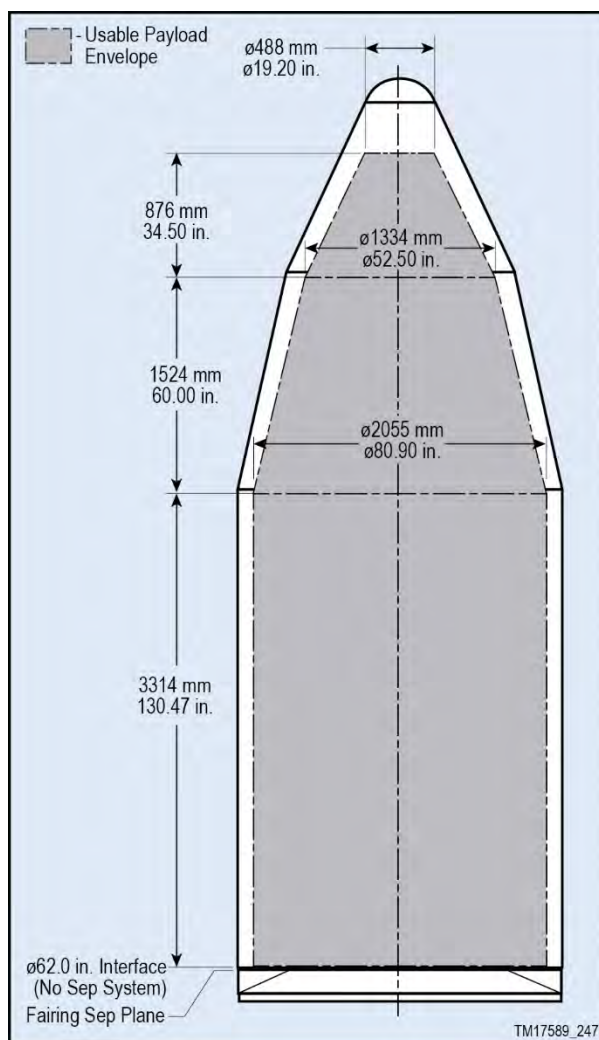

Figure 5.2.4.1-2. Dynamic Envelope for Standard 92'' Fairing with Optional 62'' Payload Cone

5.2.4.2. Dual and Multi Payload Adapter Fittings

The Minotaur launch vehicle design flexibility and performance readily accommodates multiple spacecraft that are independently deployed when required.

5.2.4.2.1. Dual-Payload Adapter Fitting

Provisions for larger multiple payloads exist for the Minotaur IV launch vehicle. A flight proven Dual Payload

Attach Fitting (DPAF) supports delivery of two primary spacecraft to orbit. The structure that supports the dual payload configuration includes a 1600 mm (63 in.) diameter cylindrical section that is configurable in height depending on payload unique requirements. In the DPAF configuration, the aft positioned spacecraft mounts to a cone inside the cylinder which is in turn mounted to the forward flange of the 62 in. payload adapter cone. The forward positioned spacecraft is then mounted to a cone on the forward end of the DPAF cylinder using a 986 mm (38.81 in.) separation system. After the forward positioned spacecraft deploys, its respective payload cone is separated from the launch vehicle followed by deployment of the aft spacecraft from inside the DPAF cylinder, also using a 986 mm (38.81 in.) separation system. The separation systems are addressed in Section 5.2.5. The DPAF is qualified to a maximum height of 2.26 m (89 in.). Both payloads would interface to the standard, non-separating 986 mm (38.81 in.) diameter mechanical interface shown in 5.2.3-1. The fairing envelope with the DPAF option is shown in Figure 5.2.4.2.1-1.

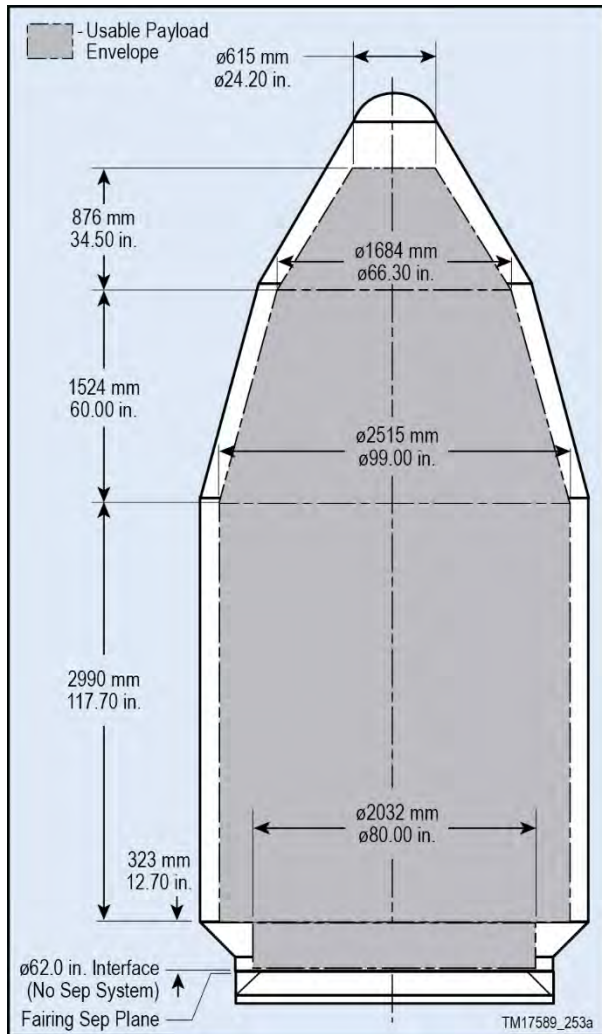

Figure 5.2.4.1-3. Dynamic Envelope for Optional 110" Fairing with Optional 62" Payload Cone

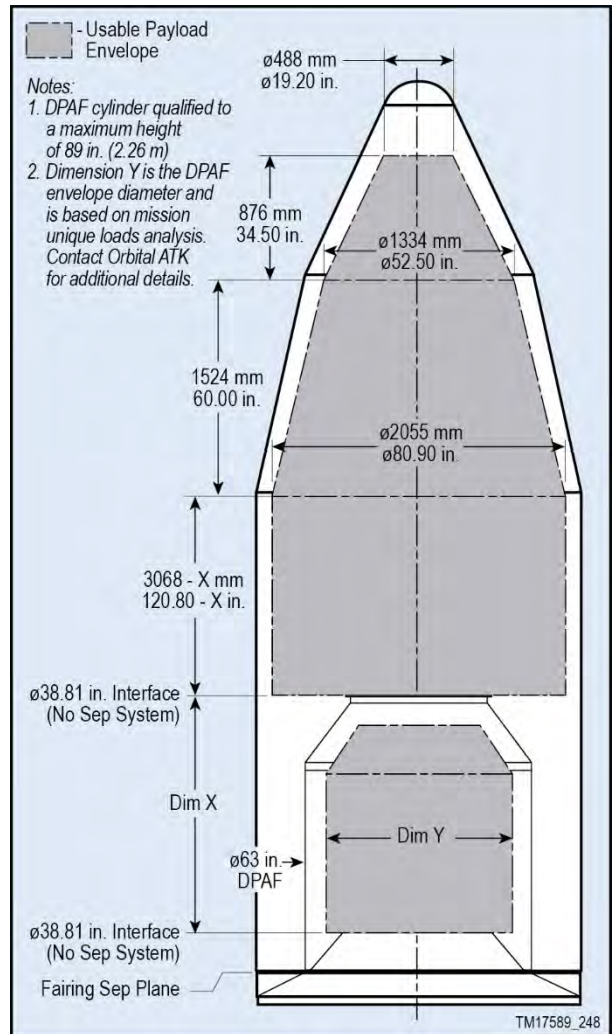

Figure 5.2.4.2.1-1. Dynamic Envelope for Standard 92" Fairing with Optional DPAF

5.2.4.2.2. Multi-Payload Adapter Fitting (MPAF)

The Multi-Payload Adapter Fitting (MPAF) utilizes a flight proven multi-payload design. The MPAF supports up to eight individual payloads including four ESPA class (610 by 711 by 965 mm (24 by 28 x 38 in.) envelope), 181 kg (400 lbm) payloads on the Multiple Payload Adapter Plate (MPAP) and four secondary 29.5 kg (65 lbm) payloads on the adapter cylinder with an allowable size envelope of 483 by 495 by 1219 mm (19 by 19.5 by 48 in.) each. The adapter cylinder can also accommodate two 59 kg (130 lbm) payloads in place of four 29.5 kg (65 lbm) payloads. The upper MPAP plate can also be implemented independent of the adapter cylinder described above that allows a single Minotaur IV launch vehicle to support four Evolved Expendable Launch Vehicle (EELV) Secondary Payload Adapter (ESPA) class payloads. The fairing envelope with the MPAF option is shown in Figure 5.2.4.2.2-1. The mechanical interface to the MPAP is shown in Figure 5.2.4.2.2-2.

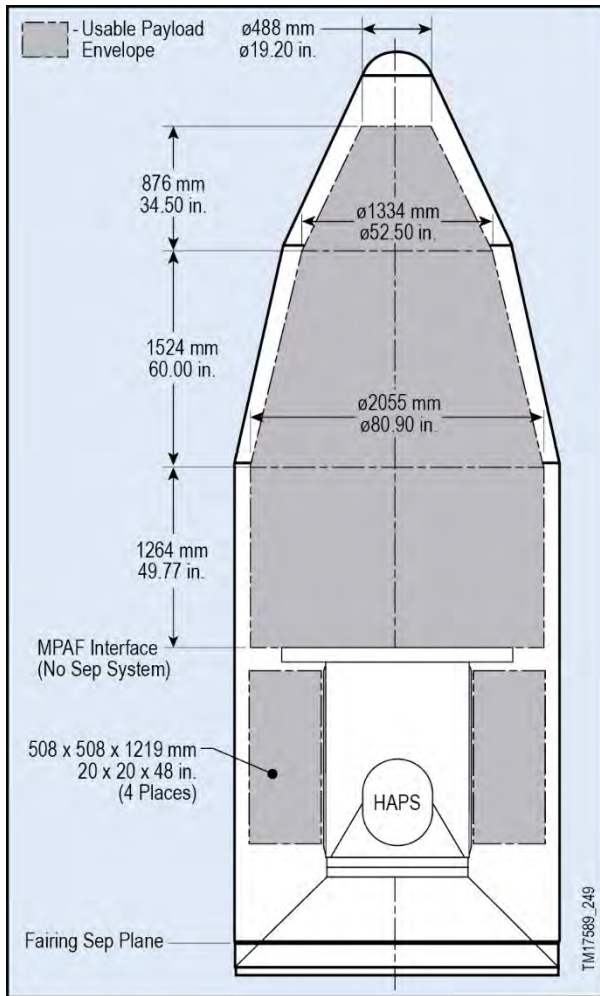

Figure 5.2.4.2.2-1. Dynamic Envelope for Standard 92” Fairing with Optional MPAF

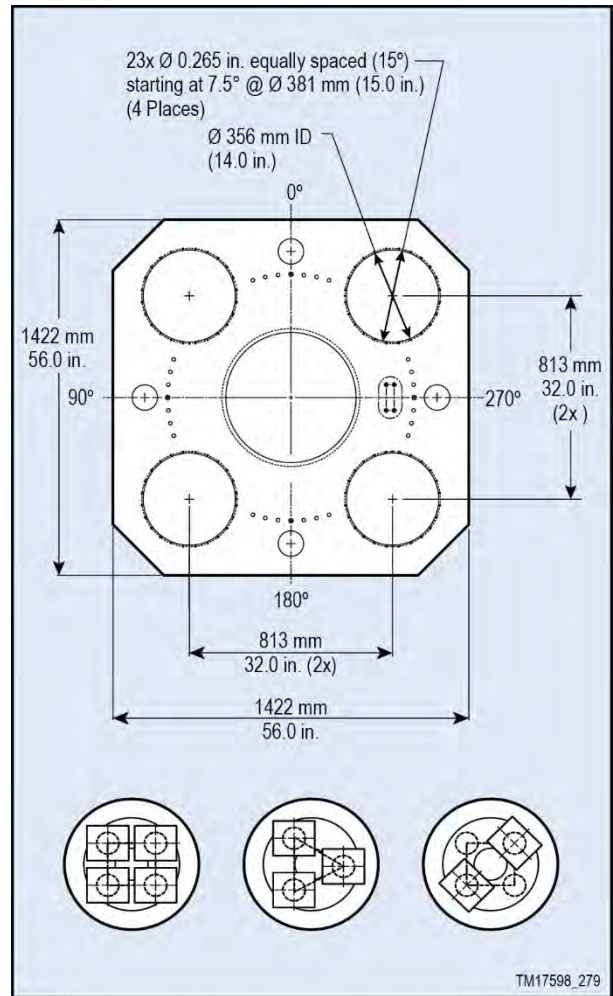

Figure 5.2.4.2.2-2. Optional Multi-Payload Adapter Plate (MPAP) Non-Separating Mechanical Interface – Accommodates 2 to 4 ESPA-Class Payloads

5.2.4.2.3. Minotaur V and VI+ Payload Adapter Fitting

The Minotaur V and VI+ baseline interface is the standard 38.81 in. non-separating interface as shown in Figure 5.2.3-1. The Minotaur V and VI+ fairing envelope with this interface is shown in Figure 5.2.4.2.3-1. In addition to the baseline interface, there is an optional Minotaur V Payload Attach Fitting (PAF) between the LV uppermost stage and payload. It is an anisogrid structure constructed of a graphite epoxy lattice winding that attaches to the forward flange of the uppermost stage forward cylinder. The fairing envelope with this PAF installed is shown in Figure 5.2.4.2.3-2. The PAF adapts to a 803 mm (31.6 in.) diameter spacecraft interface ring, as shown in Figure 5.2.4.2.3-3.

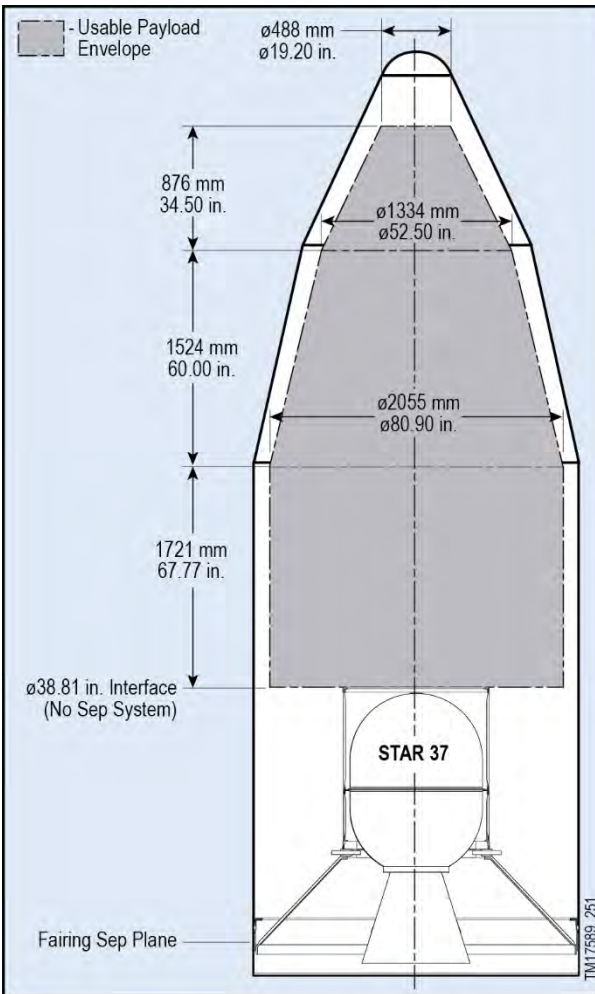

Figure 5.2.4.2.3-1. Dynamic Envelope for Standard 92" Fairing and Minotaur V / VI+ Enhanced Performance Option

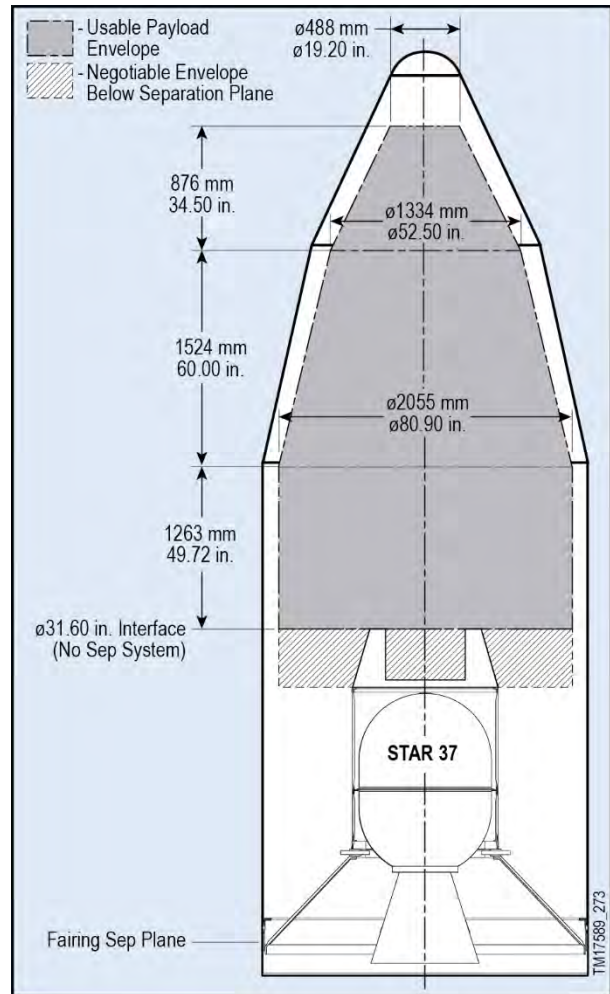

Figure 5.2.4.2.3-2. Dynamic Envelope for Standard 92" Fairing and Minotaur V / VI+ Enhanced Performance Option with Optional PAF

5.2.5. Optional Separation Systems

Three separation system options are offered as flight proven enhancements for Minotaur IV family of launch vehicles. All systems are configurable to various interface diameters and have extensive flight history. These separation systems include the NGIS Pegasus-developed marmon clamp band system, Planetary Systems Corp. Motorized Lightband (MLB) System, and RUAG low-shock marmon clamp band system. Through this enhancement, NGIS procures the qualified separation system hardware, conducts separation testing and analyses, and integrates the system onto the launch vehicle. The separation system options are summarized in Table 5.2.5-1.

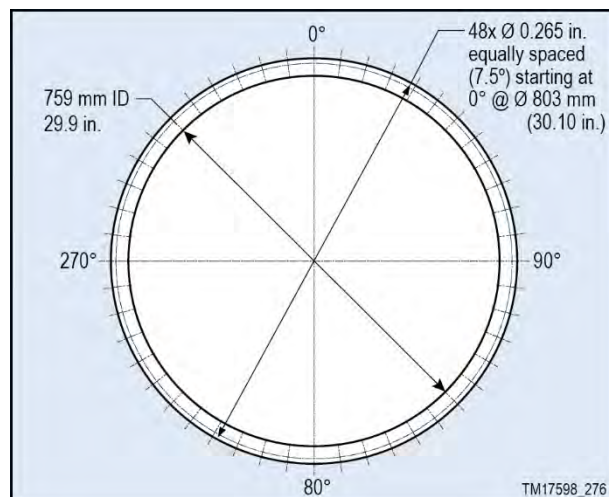





Figure 5.2.4.2.3-3. Minotaur V PAF Non-Separating Mechanical Interface

The primary separation parameters associated with a separation system are payload tip-off and overall separation velocity. Payload tip-off refers to the angular velocity imparted to the payload upon separation due to payload CG offsets and an uneven distribution of torques and forces. Payload tip-off rates induced by the separation systems presented are generally under 1 deg/sec per axis. Entering into the payload separation phase, the launch vehicle reduces vehicle rates. The combined tip-off rate of the separation system and launch vehicle is generally less than 2 deg/sec about each axis when spacecraft mass CG offsets are within specified limits presented in Section 5.4.1. Separation velocities are usually optimized to provide the spacecraft with the lowest separation velocity while ensuring recontact does not occur between the payload and the Minotaur upper stage after separation. The spacecraft is ejected by matched push-off springs with sufficient energy to produce the required relative separation velocity to prevent re-contact with the spacecraft. If non-standard separation velocities are needed, alternative springs may be substituted on a mission-specific basis as a non-standard service. Payload separation dynamics are highly dependent on the mass properties of the payload and the particular separation system utilized. Typical separation velocity is 0.6 to 0.9 m/sec (2 to 3 ft/sec). As a standard service, NGIS performs a mission-specific tip-off and separation analyses for each spacecraft.

Table 5.2.5-1. Minotaur IV Separation System Options

Separation System	Description	Photo
NGIS 38" Separation System	Height: 100 mm (3.95 in.) SV Interface Diameter: 986 mm (38.81 in.) Total Mass: 12.24 kg (26.95 lbm) Mass Attached to SV Post Sep: 4.0 kg (8.7 lbm) Separation Mechanism: Marmon clamp band with dual redundant bolt cutters	
Planetary Systems Motorized Lightband (MLB)	Height: 53.3 mm (2.10 in.) SV Interface Diameter: 986 mm (38.81 in.) Total Mass: 8.85 kg (19.51 lbm) Mass Attached to SV Post Sep: 2.04 kg (4.50 lbm) Separation Mechanism: Mechanically-actuated hinged leaves with dual redundant release motors	
RUAG 937S Low Shock System	Height: 140.7 mm (5.54 in.) SV Interface Diameter: 986 mm (38.81 in.) Total Mass: 19.89 kg (43.85 lbm) Mass Attached to SV Post Sep: 6.16 kg (13.55 lbm) Separation Mechanism: Clamp band with clamp band opening device (CBOD) that uses redundant ordnance initiated pin puller	
RUAG 937B Separation System	Height: 140.7 mm (5.54 in.) SV Interface Diameter: 986 mm (38.81 in.) Total Mass: 18.25 kg (40.15 lbm) Mass Attached to SV Post Sep: 5.18 kg (11.40 lbm) Separation Mechanism: Clamp band with clamp band with redundant ordnance initiated bolt cutter	

5.2.5.1. NGIS 38" Separation System

The flight proven NGIS 38" separation system, Figure 5.2.5.1-1, is more suitable for lighter weight payloads and is composed of two rings connected by a marmon clamp band which is separated by redundant bolt cutters. This system has flown successfully on over forty NGIS launch vehicle missions to date. The weight of hardware separated with the payload is approximately 8.7 lbm (4.0 kg). NGIS-provided attachment bolts to this interface can be inserted from either the launch vehicle or the payload side of the interface via the through-holes in the separation system flange.

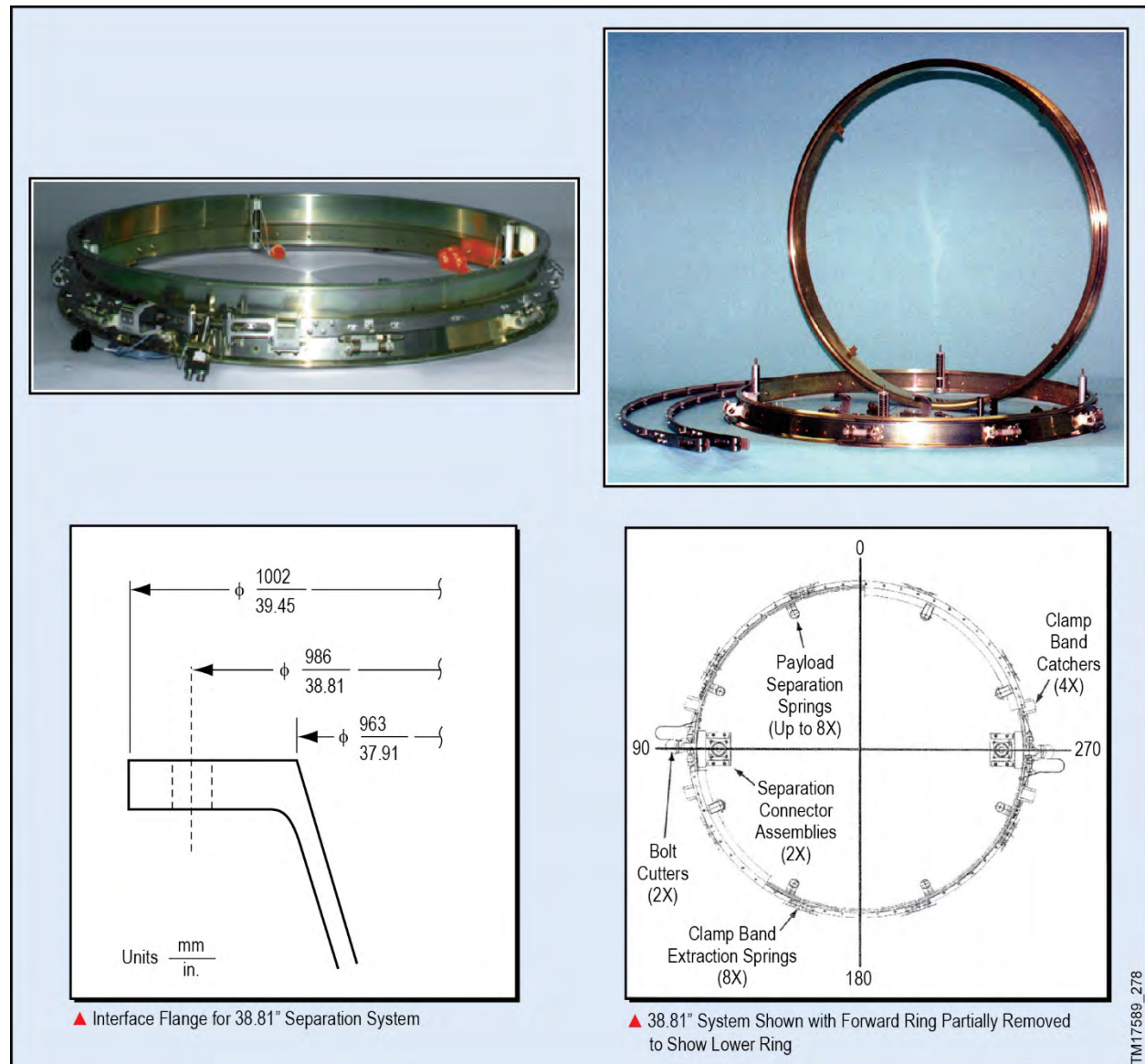

Figure 5.2.5.1-1. NGIS 38" Separation System

5.2.5.2. Planetary Systems Motorized Lightband (MLB)

The Planetary Systems MLB, Figure 5.2.5.2-1, provides a fully qualified and flight proven low shock and lightweight option for use on Minotaur missions. Multiple sizes of MLBs have previously flown on Minotaur vehicles. The MLB uses a system of mechanically-actuated hinged leaves, springs, and a dual redundant release motor to separate the upper ring (mounted to the spacecraft) from the lower ring. The MLB is flexible and configurable to support various separation force requirements and number of required separation connectors. The MLB upper ring interfaces to the spacecraft through holes in the upper ring and remains attached after separation adding approximately 2.04 kg (4.5 lb) of mass. Due to the unique design of the system and space constraints for tooling, NGIS provided socket head cap screw mating hardware must be inserted from the launch vehicle side. The MLB offers the unique ability to perform separation verification tests both at a component and system level.



Figure 5.2.5.2-1. 38" Planetary Sciences Motorized Lightband

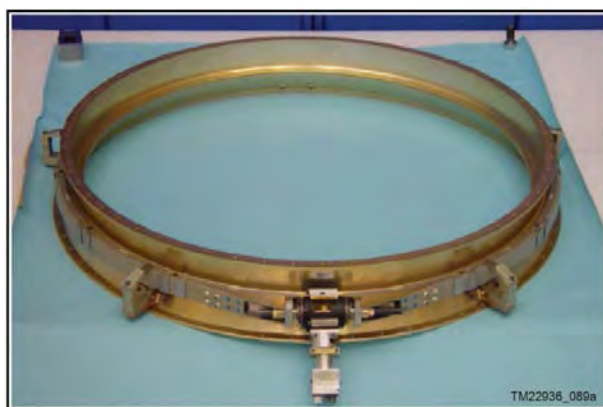

Figure 5.2.5.3-1. RUAG 937S 38" Separation System

5.2.5.3. RUAG 937 Separation Systems

There are two available RUAG separation systems. The traditional RUAG 937B is a lower cost, flight proven design composed of two rings and a clamp band separated by bolt cutters. The RUAG 937S separation system, Figure 5.2.5.3-1, is flight proven, low-shock separation system that offers outstanding load capability. This system is composed of two rings and a clamp band separated by a Clamp Band Opening Device (CBOD) rather than traditional bolt cutters. The CBOD uses a redundant, ordnance initiated pin puller device to convert strain energy, created by the clamp band tension, into kinetic energy through a controlled event that greatly reduces separation shock. Hardware separated with the payload is approximately 5.18 kg (11.40 lbm) for the 937B and 6.2 kg (13.6 lbm) for the 937S. NGIS-provided attachment bolts to this interface can be inserted from either the launch vehicle or the payload side of the interface.

5.3. Payload Electrical Interfaces

The payload electrical interface supports battery charging, external power, discrete commands, discrete telemetry, analog telemetry, serial communication, payload separation indications, and up to 16 separate ordnance discrettes. If an optional NGIS-provided separation system is utilized, NGIS will provide all the wiring through the separable interface plane. If the option is not exercised the customer will be responsible to provide the wiring from the spacecraft to the separation plane.

5.3.1. Payload Umbilical Interfaces

Two dedicated payload umbilicals are provided with 60 circuits each from the ground to the spacecraft. These umbilicals are dedicated pass through harnesses for ground processing support. They allow the payload command, control, monitor, and power to be easily configured per each individual user's requirements. The umbilical wiring is configured as a one-to-one from the Payload/Minotaur interface through to the payload EGSE interface in the Launch Equipment Vault, the closest location for operating customer supplied payload EGSE equipment. The length of the internal umbilicals is approximately 7.62 m (25 ft). The length of the external umbilicals from the LEV/SEB to the launch vehicle ranges from approximately 38.1 m (125 ft) to 99.1 m (325 ft) depending on the launch site chosen for the mission.

Figure 5.3.1-1 details the pin outs for the standard interface umbilical. All wires are twisted, shielded pairs, and pass through the entire umbilical system, both vehicle and ground, as one-to-one to simplify and standardize the payload umbilical configuration requirements while providing maximum operational flexibility to the payload provider.

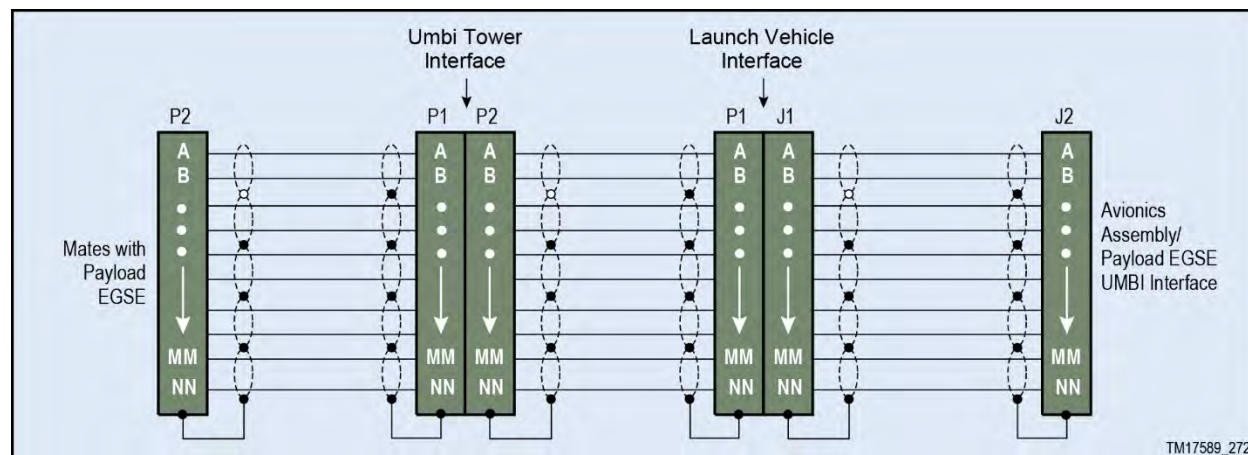

Figure 5.3.1-1. Payload 1:1 Umbilical Pin Outs

5.3.2. Payload Interface Circuitry

Standard interface circuitry passing through the payload-to-launch vehicle electrical connections is shown in Figure 5.3.2-1. This figure details the interface characteristics for launch vehicle commands, discrete and analog telemetry, separation loopbacks, pyro initiation, and serial communications interfaces with the launch vehicle avionics systems.

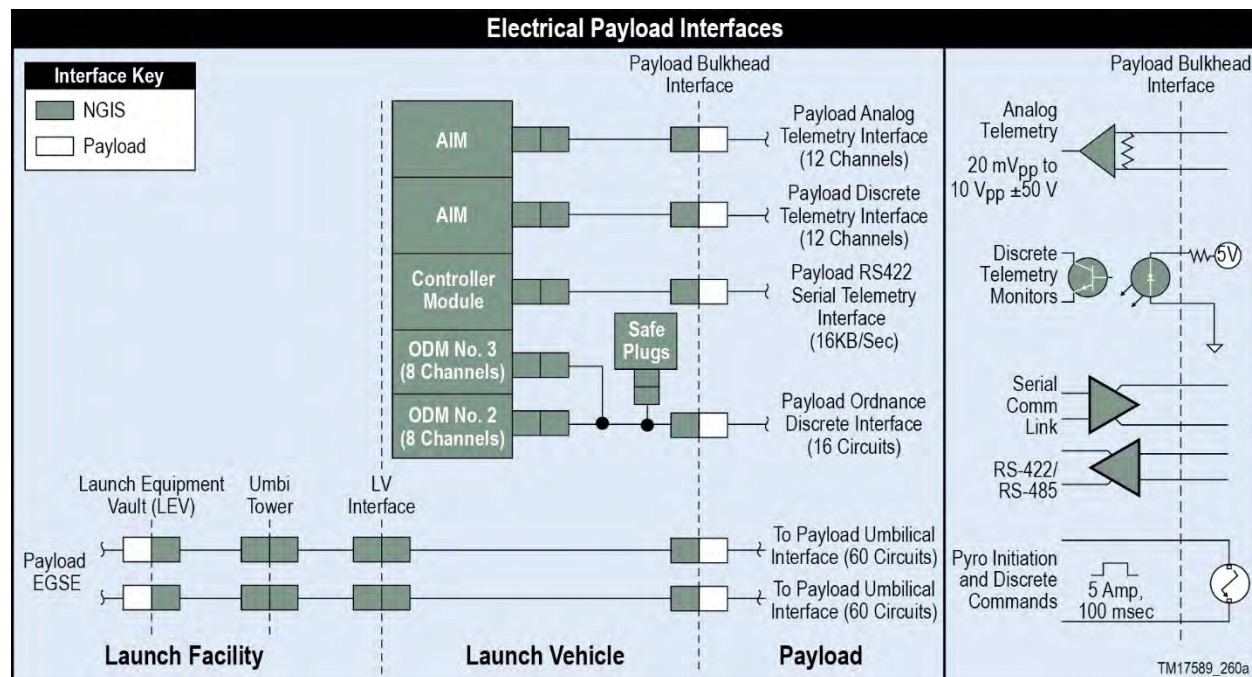

Figure 5.3.2-1. Payload Electrical Interface Block Diagram

5.3.3. Payload Battery Charging

NGIS provides the capability for remote controlled charging of payload batteries, using a customer provided battery charger. This power is routed through the payload umbilical cable. Up to 5.0 amperes per wire pair can be accommodated. The payload battery charger should be sized to withstand the line loss from the LEV to the spacecraft.

5.3.4. Payload Command and Control

The Minotaur standard interface provides discrete sequencing commands generated by the launch vehicle's Ordnance Driver Module (ODM) that are available to the payload as closed circuit opto-isolator command pulses of 5 A in lengths of 35 ms minimum. The total number of ODM discrettes is sixteen (16) and can be used for any combination of (redundant) ordnance events and/or discrete commands depending on the payload requirements.

5.3.5. Pyrotechnic Initiation Signals

NGIS provides the capability to directly initiate 16 separate pyrotechnic conductors through two dedicated MACH Ordnance Driver Modules (ODM). Each ODM provides for up to eight drivers capable of a 5 A, 100 ms, current limited pulse into a 1.5 ohm resistive load. All eight channels can be fired simultaneously with an accuracy of 1 ms between channels. In addition, the ODM channels can be utilized to trigger high impedance discrete events if required. Safing for all payload ordnance events will be accomplished either through an Arm/Disarm (A/D) Switch or Safe Plugs.

5.3.6. Payload Telemetry

The baseline telemetry subsystem capability provides a number of dedicated payload discrete (bi-level) and analog telemetry monitors through dedicated channels in the vehicle encoder. Up to 24 channels will be provided with type and data rate being defined in the mission requirements document. The payload serial and analog data will be embedded in the baseline vehicle telemetry format. For discrete monitors, the payload customer must provide the 5 Vdc source and the return path. The current at the payload interface must be less than 10 mA. Separation breakwire monitors can be specified if required. The number of analog channels available for payload telemetry monitoring is dependent on the frequency of the data. Payload telemetry requirements and signal characteristics will be specified in the Payload ICD and should not change once the final telemetry format is released at approximately L-6 months. NGIS will record, archive, and reduce the data into a digital format for delivery to the payloaders for review.

Due to the use of strategic assets, Minotaur IV telemetry is subject to the provisions of the Strategic Arms Reduction Treaty (START). START treaty provisions require that certain Minotaur vehicle telemetry be unencrypted and provided to the START treaty office for dissemination to the signatories of the treaty. The extent to which START applies to the payload telemetry will be determined by SMC/ADSL. Encrypted payload telemetry can be added as a non-standard service pending approval by SMC/ADSL and the START treaty office.

5.3.7. Payload Separation Monitor Loopbacks

Separation breakwire monitors are required on both sides of the payload separation plane. With the NGIS-provided separation systems, NGIS provides three (3) separation loopbacks on the launch vehicle side of the separation plane for positive payload separation indication.

The payload will provide two (2) separation loopback circuits on the payload side of the separation plane. These are typically wired into different separation connectors for redundancy. These breakwires are used for positive separation indication telemetry and initiation of the C/CAM maneuver.

5.3.8. Telemetry Interfaces

The standard Minotaur payload interface provides a 16 kbps RS-422/RS-485 serial interface for payload use with the flexibility to support a variety of channel/bit rate requirements, and provide signal conditioning, PCM formatting (programmable) and data transmission bit rates. The number of channels, sample rates, etc. will be defined in the Payload ICD.

5.3.9. Non-Standard Electrical Interfaces

Non-standard services such as serial command and telemetry interfaces can be negotiated between NGIS and the payload on a mission-by-mission basis. The selection of the separation system could also impact the payload interface design and will be defined in the Payload ICD.

5.3.10. Electrical Launch Support Equipment

NGIS will provide space for a rack of customer supplied EGSE in the LCR, and at the on-pad LEV or Support Equipment Building (SEB). The equipment will interface with the launch vehicle/spacecraft through either the dedicated payload umbilical interface or directly through the payload access door. The payload customer is responsible for providing cabling for their EGSE within the LCR, LEV, and SEB to the appropriate umbilical interface.

Separate payload ground processing harnesses that mate directly with the payload can be accommodated through the payload access door(s) as defined in the Payload ICD. The payload will provide all cabling for this operation.

5.4. Payload Design Constraints

The following sections provide design constraints to ensure payload compatibility with the Minotaur launch vehicle.

5.4.1. Payload Center of Mass Constraints

Along the Y and Z-axes, the payload CG must be within 1.0 inch (2.54 cm) of the vehicle centerline. Payloads whose CG extend beyond the 1.0 inch lateral offset limit will require NGIS to verify the specific offsets that can be accommodated.

5.4.2. Final Mass Properties Accuracy

In general, the final mass properties statement must specify payload weight to an accuracy of $\pm 0.5\%$ of the payload mass, the center of gravity to an accuracy of at least 0.64 cm (0.25 in.) in each axis, moment of inertia to $\pm 5\%$, and the products of inertia to an accuracy of less than 2.7 kg-m² (2.0 slug-ft²), as shown in Table 5.4.2-1. However these accuracies may vary on a mission specific basis. In addition, if the payload uses liquid propellant, the slosh frequency must be provided to an accuracy of 0.2 Hz, along with a summary of the method used to determine slosh frequency.

Table 5.4.2-1. Payload Mass Properties Measurement Tolerance

Component	Accuracy
Mass	$\pm 0.5\%$
Principal Moments of Inertia	$\pm 5\%$
Cross Products of Inertia	$\pm 2.7 \text{ kg} - \text{m}^2$ ($\pm 2.0 \text{ slug} - \text{ft}^2$)
Center of Gravity X, Y, and Z Axes	$\pm 0.64 \text{ cm}$ ($\pm 0.25 \text{ in.}$)

5.4.3. Pre-Launch Electrical Constraints

Prior to launch, all payload electrical interface circuits are constrained to ensure there is no current flow greater than 10 mA across the payload electrical interface plane. The primary support structure of the spacecraft shall be electrically conductive to establish a single point electrical ground.

5.4.4. Payload EMI/EMC Constraints

The Minotaur avionics are in close proximity to the payload inside the fairing such that radiated emissions compatibility is paramount. NGIS places no firm radiated emissions limits on the payload other than the prohibition against RF transmissions within the payload fairing. Prior to launch, NGIS requires review of the payload radiated emission levels (MIL-STD-461, RE02) to verify overall launch vehicle EMI safety margin (emission) in accordance with MIL-E-6051. Payload RF transmissions are not permitted after fairing mate and prior to an ICD specified time after separation of the payload. An EMI/EMC analysis may be required to ensure RF compatibility.

Payload RF transmission frequencies must be coordinated with NGIS and range officials to ensure non-interference with Minotaur and range transmissions. Additionally, the customer must schedule all RF tests at the integration site with NGIS in order to obtain proper range clearances and protection.

5.4.5. Payload Dynamic Frequencies

To avoid dynamic coupling of the payload modes with the natural frequency of the launch vehicle, the spacecraft should be designed with a structural stiffness to ensure that the lateral fundamental frequency

of the spacecraft, fixed at the spacecraft interface is typically greater than 15 Hz lateral. However, this value is significantly affected by other factors such as incorporation of a spacecraft isolation system and/or separation system. Therefore, the final determination of compatibility must be made on a mission-specific basis.

5.4.6. Payload Propellant Slosh

A slosh model should be provided to NGIS in either the pendulum or spring-mass format. Data on first sloshing mode are required and data on higher order modes are desirable. Additional critical model parameters will be established during the mission development process. The slosh model should be provided with the payload finite element model submittals.

5.4.7. Payload-Supplied Separation Systems

If the payload employs a non-NGIS separation system, then the shock delivered to the LV interface must not exceed the limit level characterized in Section 4.3 (Figure 4.4-2). Shock above the stated level could require a requalification of LV components.

5.4.8. System Safety Constraints

OSP considers the safety of personnel and equipment to be of paramount importance. AFSPCM 91-710 outlines the safety design criteria for Minotaur payloads. These are compliance documents and must be strictly followed. It is the responsibility of the customer to ensure that the payload meets all OSP, NGIS, and range imposed safety standards.

Customers designing payloads that employ hazardous subsystems are advised to contact OSP early in the design process to verify compliance with system safety standards.

This page left intentionally blank.

6. MISSION INTEGRATION

6.1. Mission Management Approach

OSP-3 is managed through U.S. Air Force, Space and Missile Systems Center, Advanced Systems and Development Directorate (SMC/AD), Rocket Systems Launch Program (SMC/ADSL). SMC/ADSL serves as the primary point of contact for the payload customers for the Minotaur launch service. The organizations involved in the Mission Integration Team are shown in Figure 6.1-1. Open communication between SMC/ADSL, NGIS, and the customer, with an emphasis on timely data transfer and prudent decision-making, ensures efficient launch vehicle/payload integration operations.

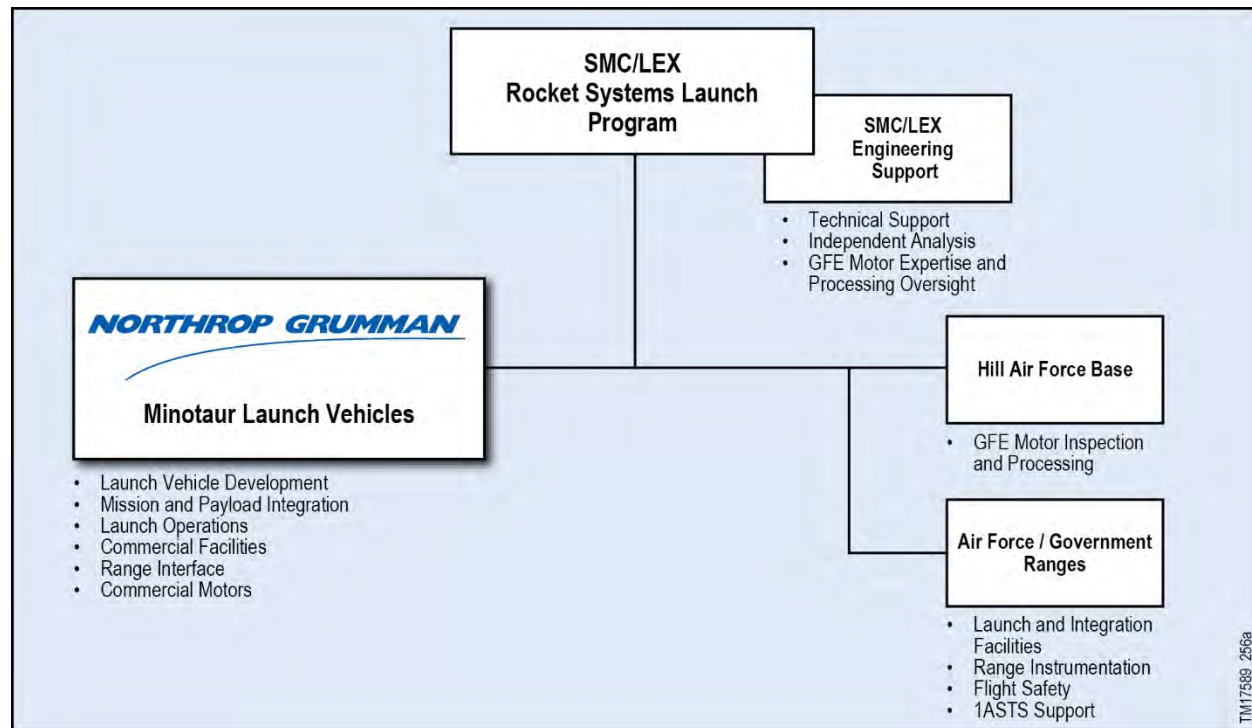

Figure 6.1-1. Mission Integration Team

6.1.1. SMC/ADSL Mission Responsibilities

SMC/ADSL is the primary focal point for all contractual and technical coordination. SMC/ADSL contracts with NGIS to provide the Launch Vehicle, launch integration, and commercial facilities (i.e., spaceports, clean rooms, etc.). Separately, they contract with Government Launch Ranges for launch site facilities and services. Once a mission is identified, SMC/ADSL will assign a government Mission Manager to coordinate all mission planning and contracting activities. SMC/ADSL is supported by associate contractors for both technical and logistical support, capitalizing on their extensive expertise and background knowledge of the Peacekeeper booster and subsystems.

6.1.2. NGIS Mission Responsibilities

As the launch vehicle provider, NGIS' responsibilities fall into four primary areas:

- a. Launch Vehicle Program Management
- b. Mission Management
- c. Engineering
- d. Launch Site Operations

The Minotaur organization uses highly skilled personnel with extensive Minotaur experience. The Minotaur program is led by a Program Director who reports directly to NGIS' Launch Vehicles Division (LVD) General Manager and has full responsibility for mission success. This direct line to executive management provides high visibility, ensuring access to critical organizational resources. Supporting the Program Director is the Minotaur Chief Engineer, who provides technical direction and oversight to maintain standard practices across NGIS' family of Minotaur launch vehicles.

For new missions, a Program Management team is assigned. Leading this team is the Program Manager, whose primary responsibilities include developing staff requirements, interpreting contract requirements as well as managing schedules and budgets for the mission. A Program Engineering Manager (PEM) is assigned to provide management and technical direction to all engineering department personnel assigned to the mission. The PEM is the single focal point for all engineering activity and functions as the chief technical lead for the mission and technical advisor to the Program Manager. In addition, the PEM serves as the single point of contact for the OSP-3 Government COR.

NGIS also assigns a Mission Manager that serves as the primary interface to the SMC/ADSL Mission Manager and payload provider. This person has overall mission responsibility to ensure that payload requirements are met and that the appropriate launch vehicle services are provided. They do so via detailed mission planning, payload integration scheduling, systems engineering, mission-peculiar design and analyses coordination, payload interface definition, and launch range coordination. The NGIS Mission Manager will jointly chair Working Group meetings with the SMC/ADSL Mission Manager.

Engineering Leads and their supporting engineers conduct detailed mission design and analyses, perform integration and test activities, and follow the hardware to the field site to ensure continuity and maximum experience with that mission's hardware.

Launch Site Operations are carried out by the collective Minotaur team as detailed in Section 7.0. A Launch Site Integration and Operations lead are typically assigned and on-site full-time to manage day-to-day launch site activities.

6.2. Mission Planning and Development

NGIS will assist the customer with mission planning and development associated with Minotaur launch vehicle systems. These services include interface design and configuration control, development of integration processes, launch vehicle analyses and facilities planning. In addition, launch campaign planning that includes range services, integrated schedules and special operations.

The procurement, analysis, integration and test activities required to place a customer's payload into orbit are typically conducted over a 26 month standard sequence of events called the Mission Cycle. This cycle normally begins 24 months before launch, and extends to 8 weeks after launch.

The Mission Cycle is initiated upon receipt of the contract authority to proceed. The contract option designates the payload, launch date, and basic mission parameters. In response, the Minotaur Program Manager designates an NGIS Mission Manager who ensures that the launch service is supplied efficiently, reliably, and on-schedule.

The typical Mission Cycle interweaves the following activities:

- a. Mission management, document exchanges, meetings, and formal reviews required to coordinate and manage the launch service.
- b. Mission analyses and payload integration, document exchanges, and meetings.
- c. Design, review, procurement, testing and integration of all mission-peculiar hardware and software.
- d. Range interface, safety, and flight operations activities, document exchanges, meetings and reviews.

Figure 6.2-1 details the typical Mission Cycle and how this cycle folds into the NGIS vehicle production schedule with typical payload activities and milestones. A typical Mission Cycle is based on a 24 month interval between mission authorization and launch. This interval reflects the OSP-3 contractual schedule and has been shown to be an efficient schedule based on NGIS' past program execution experience. OSP-3 does allow flexibility to negotiate either accelerated or extended mission cycles that may be required by unique payload requirements. Payload scenarios that might drive a change in the duration of the mission cycle include those that have funding limitations, rapid response demonstrations, extensive analysis needs or contain highly complex payload-to-launch vehicle integrated designs or tests.

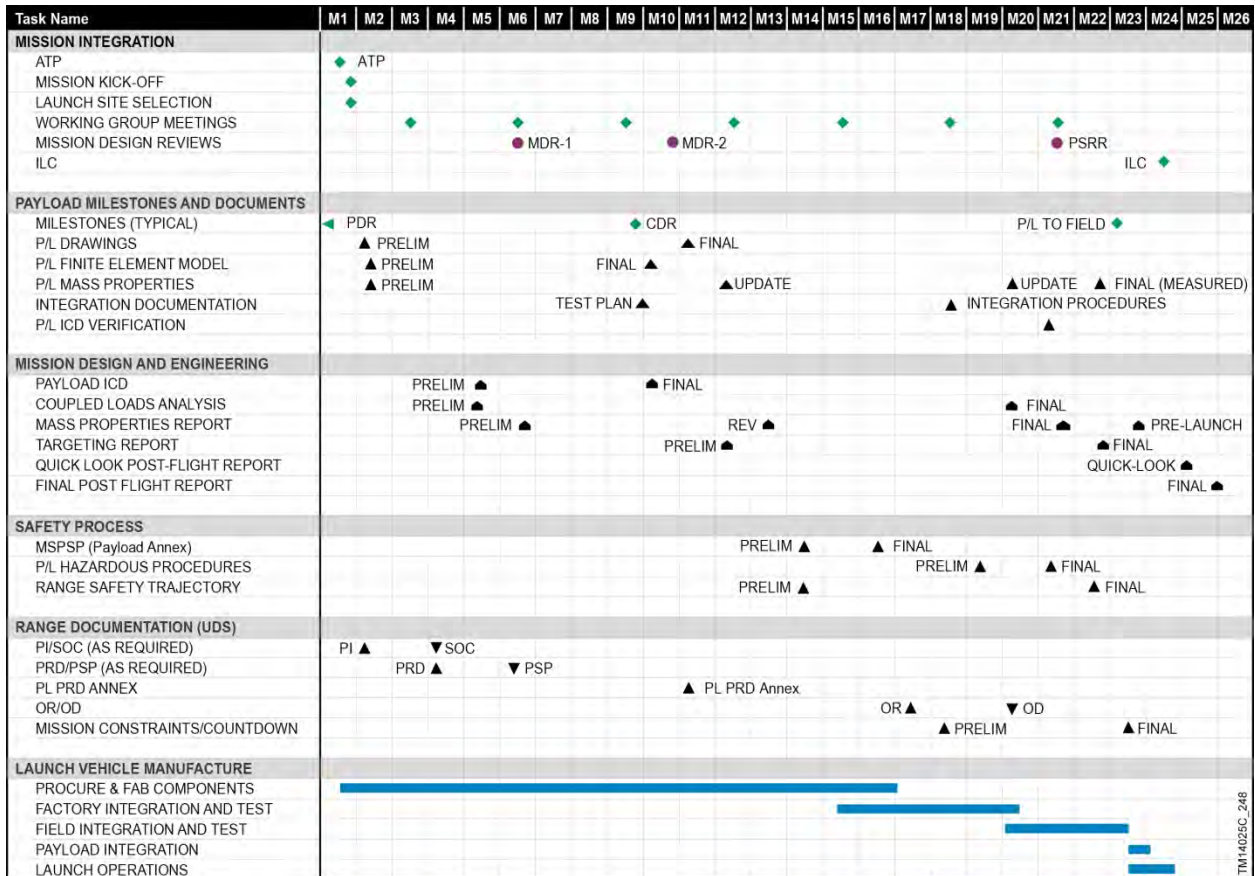

Figure 6.2-1. Typical Mission Integration Schedule

A typical mission field integration schedule is provided in Figure 6.2-2. The field integration schedule is adjusted as required based on the mission requirements, launch vehicle configuration and launch site selection.

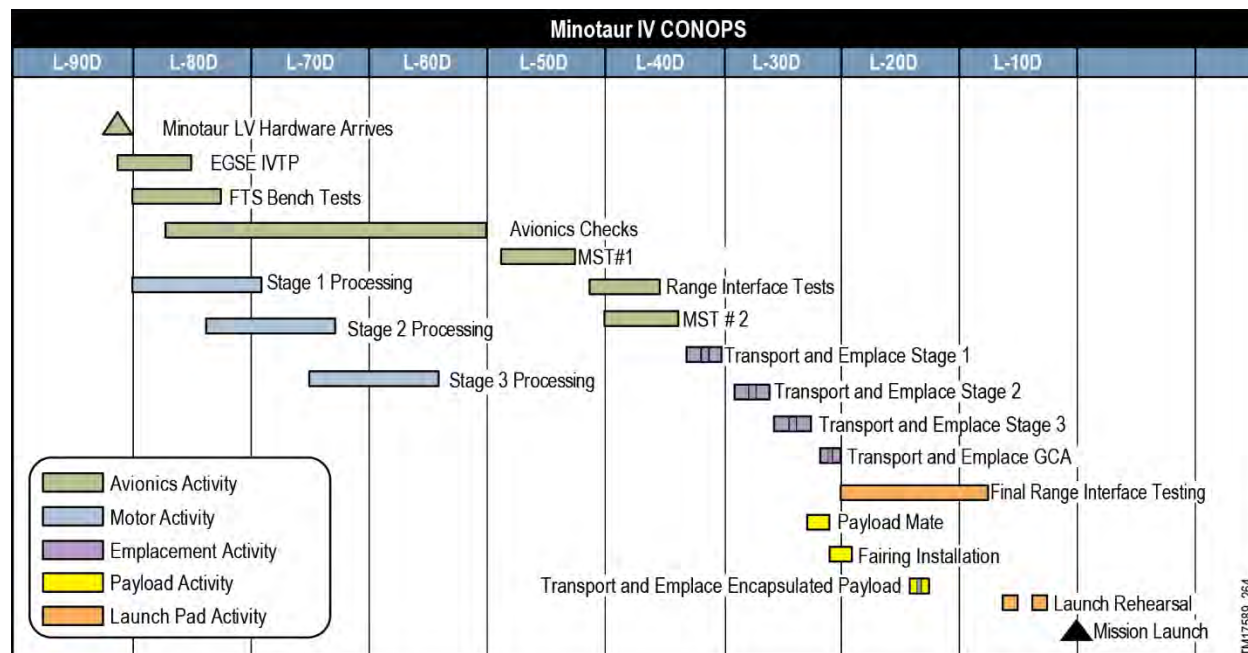

Figure 6.2-2. Typical Mission Field Integration Schedule

6.2.1. Mission Assurance

The OSP-3 contract has three tailored levels of Mission Assurance (MA); Category 1, Category 2 and Category 3. These categories provide progressively increasing levels of government oversight, above and beyond NGIS rigorous internal MA standards.

Category 1 MA is the simplest, relying on NGIS' robust internal MA standards and processes, and does not require SMC/ADSL flight worthiness certification or Government IV&V oversight. Category 1 missions will be licensed under Federal Aviation Administration (FAA) licensing guidelines.

Category 2 MA builds upon Category 1 and dictates that NGIS provide additional information and support for the government's MA efforts and the government's Independent Readiness Review Team (IRRT). NGIS will provide support for SMC/ADSL's Spaceflight Worthiness Certification, independent IV&V, requirements decomposition and verification, testing (planning, qualification, design verification), as well as additional reviews and activities both pre and post launch. Category 2 MA represents what has traditionally been the standard level of MA on past Minotaur missions.

Category 3 MA builds upon the requirements of Category 2 and are subject to increased breadth and depth of government IV&V and insight. Up to ten dedicated IRRT reviews may be required, with monthly 1-day Program Management Reviews throughout the period of performance, as well as weekly 2-hour telecons to communicate current status of concerns and action items. Category 3 is intended mainly for high value DoD missions similar to Acquisition Category 1 (ACAT-1).

6.3. Mission Integration Process

6.3.1. Integration Meetings

The core of the mission integration process consists of a series of Mission Integration and Range Working Groups (MIWG and RWG, respectively). The MIWG has responsibility for all physical interfaces between the payload and the launch vehicle. As such, the MIWG develops the Payload-to-Minotaur ICD in addition to all mission-unique analyses, hardware, software, and integrated procedures. The RWG is responsible for items associated with launch site operations. Examples of such items include range interfaces, hazardous procedures, system safety, and trajectory design. Documentation produced by the RWG includes all required range and safety submittals.

Working Group membership consists of the Mission Manager and representatives from Minotaur engineering and operations organizations, as well as their counterparts from the customer organization. Quarterly meetings are typical, however the number of meetings required to develop and implement the mission integration process will vary based on the complexity of the spacecraft.

6.3.2. Mission Design Reviews (MDR)

Two mission-specific design reviews will be held to determine the status and adequacy of the launch vehicle mission preparations. They are designated MDR-1 and MDR-2 and are typically held 6 months and 13 months, respectively, after authority to proceed. They are each analogous to Preliminary Design Reviews (PDRs) and Critical Design Reviews (CDRs), but focus primarily on mission-specific elements of the launch vehicle effort.

6.3.3. Readiness Reviews

During the integration process, readiness reviews are held to provide the coordination of mission participants and gain approval to proceed to the next phase of activity from senior management. Due to the variability in complexity of different payloads, missions, and mission assurance categories, the content and number of these reviews are tailored to customer requirements. A brief description of each readiness review is provided below:

- a. **Pre-Ship Readiness Review (PSRR)** — Conducted prior to committing flight hardware and personnel to the field. The PSRR provides testing results on all formal systems tests and reviews the major mechanical assemblies which are completed and ready for shipping at least L-60 days. Safety status and field operations planning are also provided covering Range flight termination, ground hazards, spaceport coordination status, and facility preparation and readiness.
- b. **Incremental Readiness Review (IRR)** – The quantity and timing of IRR(s) depends on the complexity and Mission Assurance Category of the mission. IRRs typically occur 2-12 months prior to the launch date. IRR provides an early assessment of the integrated launch vehicle/payload/facility readiness.
- c. **Mission Readiness Review (MRR)** — Conducted within 2 months of launch, the MRR provides a pre-launch assessment of integrated launch vehicle/payload/facility readiness prior to committing significant resources to the launch campaign.
- d. **Flight Readiness Review (FRR)** – The FRR is conducted at L-10 days and determines the readiness of the integrated launch vehicle/payload/facility for a safe and successful launch. It also ensures that all flight and ground hardware, software, personnel, and procedures are operationally ready.
- e. **Launch Readiness Review (LRR)** — The LRR is conducted at L-1 day and serves as the final assessment of mission readiness prior to activation of range resources on the day of launch.

6.4. Documentation

Integration of the payload requires detailed, complete, and timely preparation and submittal of interface documentation. SMC/ADSL is the primary communication path with other U.S. Government agencies, which include—but are not limited to—the various Ranges and their support agencies, the U.S. Department of Transportation, U.S. State Department, and U.S. Department of Defense. The major products and submittal times associated with these organizations are divided into two areas—those products that are provided by the customer, and those produced by NGIS. Customer-provided documents represent the formal communication of requirements, safety data, system descriptions, and mission operations planning.

6.4.1. Customer-Provided Documentation

Documentation produced by the customer is detailed in the following paragraphs.

6.4.1.1. Payload Questionnaire

The Payload Questionnaire is designed to provide the initial definition of payload requirements, interface details, launch site facilities, and preliminary safety data. Prior to the Mission Kickoff Meeting, the customer shall provide the information requested in the Payload Questionnaire form (Appendix A). Preliminary payload drawings, as well as any other pertinent information, should also be included with the response. The customer's responses to the payload questionnaire define the most current payload requirements and interfaces and are instrumental in NGIS' preparation of numerous documents including the ICD, Preliminary Mission Analyses and launch range documentation. NGIS understands that a definitive response to some questions may not be feasible prior to the Mission Kickoff Meeting as they will be defined during the course of the mission integration process.

6.4.1.2. ICD Inputs

The LV-to-payload ICDs (mission, mechanical and electrical) detail all the mission specific requirements agreed upon by NGIS and the customer. These key documents are used to ensure the compatibility of all launch vehicle and payload interfaces, as well as defining all mission-specific and payload- unique requirements. As such, the customer defines and provides to NGIS all the inputs that relate to the payload. These inputs include those required to support flight trajectory development (e.g., orbit requirements, payload mass properties, and payload separation requirements), mechanical and electrical interface definition, payload unique requirements, payload operations, and ground support requirements.

6.4.1.3. Payload Mass Properties

Payload mass properties must be provided in a timely manner in order to support efficient launch vehicle trajectory development and dynamic analyses. Preliminary mass properties should be submitted as part of the MRD at launch vehicle authority to proceed. Updated mass properties shall be provided at predefined intervals identified during the initial mission integration process. Typical timing of these deliveries is included in Figure 6-2.

6.4.1.4. Payload Finite Element Model

A payload mathematical model is required for use in NGIS' preliminary coupled loads analyses. Acceptable forms include either a Craig-Bampton model valid to 120 Hz or a NASTRAN finite element model. For the final coupled loads analysis, a test verified mathematical model is desired.

6.4.1.5. Payload Thermal Model for Integrated Thermal Analysis

An integrated thermal analysis can be performed for any payload as a non-standard service. A payload thermal model will be required from the payload organization for use in NGIS' integrated thermal analysis if it is required. The analysis is conducted for three mission phases:

- a. Prelaunch ground operations;
- b. Ascent from lift-off until fairing jettison; and
- c. Fairing jettison through payload deployment.

The preferred thermal model format is Thermal Desktop, although FEMAP and SINDA/G can also be provided. There is no limit on model size; however, larger models may increase the turn-around time.

6.4.1.6. Payload Drawings

NGIS prefers electronic versions of payload configuration drawings to be used in the mission specific interface control drawing, if possible. NGIS will work with the customer to define the content and desired format for the drawings.

6.4.1.7. Program Requirements Document (PRD) Mission Specific Annex Inputs

In order to obtain range support, a PRD must be prepared. This document describes requirements needed to generally support the Minotaur launch vehicle. For each launch, an annex is submitted to specify the range support needed to meet the mission's requirements. This annex includes all payload requirements as well as any additional Minotaur requirements that may arise to support a particular mission. The customer completes all appropriate PRD forms for submittal to NGIS.

6.4.1.7.1. Launch Operations Requirements (OR) Inputs

To obtain range support for the launch operation and associated rehearsals, an OR must be prepared. The customer must provide all payload pre-launch and launch day requirements for incorporation into the mission OR.

6.4.1.8. Payload Launch Site Integration Procedures

For each mission, NGIS requires detailed spacecraft requirements for integrated launch vehicle and payload integration activities. With these requirements, NGIS will produce the integrated procedures for all launch site activities. In addition, all payload procedures that are performed near the LV (either at the integration facility or at the launch site or both) must be presented to NGIS for review prior to first use.

6.4.1.9. ICD Verification Documentation

NGIS conducts a rigorous verification program to ensure all requirements on both sides of the launch vehicle-to-payload interface have been successfully fulfilled. As part of the ICD, NGIS includes a verification matrix that indicates how each ICD requirement will be verified (e.g., test, analysis, demonstration, etc.). As part of the verification process, NGIS will provide the customer with a matrix containing all interface requirements that are the responsibility of the payload to meet. The matrix clearly identifies the documentation to be provided as proof of verification. Likewise, NGIS will ensure that the customer is provided with similar data for all interfaces that are the responsibility of launch vehicle to verify.

6.4.2. NGIS-Produced Documentation, Data, and Analyses

Mission documentation produced by NGIS is detailed in the following paragraphs.

6.4.2.1. Launch Vehicle to Payload ICD

The launch vehicle-to-payload ICD details all of the mission-unique requirements agreed upon by NGIS and the customer. The ICD is a critical document used to ensure compatibility of all launch vehicle and payload interfaces, as well as defining all mission-specific and mission-unique requirements. The ICD contains the payload description, electrical and mechanical interfaces, environmental requirements, targeting parameters, mission-peculiar vehicle requirement description, and unique GSE and facilities required. As a critical part of this document, NGIS provides a comprehensive matrix that lists all ICD requirements and the method in which these requirements are verified, as well as who is responsible.

The launch vehicle to payload ICD, as well as the Payload Mechanical ICD and Electrical ICD are configuration controlled documents that are approved by NGIS and the customer. Once released, changes to these documents are formally issued and approved by both parties. The ICDs are reviewed in detail as part of the MIWG process.

6.4.2.2. ICD Verification Documentation

NGIS conducts a rigorous verification program to ensure all requirements on both sides of the launch vehicle-to-payload interface have been successfully fulfilled. Like the customer-provided verification data discussed in Section 6.4.1.9, NGIS will provide the customer with similar data for all interfaces that are the responsibility of launch vehicle to verify. This documentation is used as part of the team effort to show that a thorough verification of all ICD requirements has been completed.

6.4.2.3. Preliminary Mission Analyses

NGIS performs preliminary mission analyses to determine the compatibility of the payload with the Minotaur launch vehicle and to provide succinct, detailed mission requirements such as launch vehicle trajectory information, performance capability, accuracy estimates and preliminary mission sequencing. Much of the data derived from the preliminary mission analyses is used to establish the ICD and to perform initial range coordination.

6.4.2.4. Coupled Loads Analyses (CLA)

NGIS has developed and validated finite element structural models of the Minotaur vehicle for use in CLAs with Minotaur payloads. NGIS will incorporate the customer-provided payload model into the Minotaur finite element model and perform a preliminary CLA to determine the maximum responses of the entire integrated stack under transient loads. Once a test validated spacecraft model has been delivered to NGIS, a final CLA load cycle is completed. Through close coordination between the customer and the NGIS, interim results can be made available to support the customer's schedule critical needs.

6.4.2.5. Integrated Launch Site Procedures

For each mission, NGIS prepares integrated procedures for various operations that involve the payload at the processing facility and launch site. These include, but are not limited to: payload mate to the Minotaur launch vehicle; fairing encapsulation; mission simulations; final vehicle closeouts, and transport of the integrated launch vehicle/payload to the launch pad. Once customer inputs are received, NGIS will develop draft procedures for review and comment. Once concurrence is reached, final procedures will be released prior to use. Draft hazardous procedures must be presented to the appropriate launch site safety organization 90 days prior to use and final hazardous procedures are due 45 days prior to use.

6.4.2.6. Missile System Pre-Launch Safety Package (MSPSP) Annex

The MSPSP Annex documents launch vehicle and payload safety information including an assessment of any hazards which may arise from mission-specific vehicle and/or payload functions, and is provided as an annex to the baseline Minotaur MSPSP. The customer must provide NGIS with all safety information pertaining to the payload. NGIS assesses the combined vehicle and payload for hazards and prepares a report of the findings. NGIS will then forward the integrated assessment to the appropriate launch Range for approval.

6.4.2.7. PRD Mission Specific Annex

Once customer PRD inputs are received, NGIS reviews the inputs and upon resolving any concerns or potential issues, submits the mission specific PRD annex to the range for approval. The range will respond with a Program Support Plan (PSP) indicating their ability to support the stated requirements.

6.4.2.8. Launch Operation Requirements (OR)

NGIS submits the OR to obtain range support for pre-launch and launch operations. Information regarding all aspects of launch day, particularly communication requirements, is detailed in the OR. NGIS generates the document, solicits comments from the customer, and, upon comment resolution, delivers the mission OR to the range. The range generates the Operations Directive (OD) that is used by range support personnel as the instructions for providing the pre-launch and launch day services.

6.4.2.9. Mission Constraints Document (MCD)

This NGIS-produced document summarizes launch day operations for the Minotaur launch vehicle as well as for the payload. Included in this document is a comprehensive definition of the Minotaur and payload launch operations constraints, the established criteria for each constraint, the decision making chain of command, and a summary of personnel, equipment, communications, and facilities that will support the launch.

6.4.2.10. Final Countdown Procedure

NGIS produces the launch countdown procedure that readies the Minotaur launch vehicle and payload for launch. All Minotaur and payload final countdown activities are included in the procedure.

6.4.2.11. Post-Launch Analyses

NGIS provides post-launch analyses to the customer in two forms. The first is a quick-look assessment provided within four days of launch. The quick-look data report includes preliminary trajectory performance data, orbital accuracy estimates, system performance preliminary evaluations, and a preliminary assessment of mission success.

The second post-launch analysis, a more detailed final report of the mission, is provided to the customer within 30 days of launch. Included in the final mission report are the actual mission trajectory, event times, significant events, environments, orbital parameters and other pertinent data from on-board telemetry and Range tracking sensors. Photographic and video documentation, as available, is included as well.

NGIS also analyzes telemetry data from each launch to validate Minotaur performance against the mission ICD requirements. In the case of any mission anomaly, NGIS will conduct an investigation and closeout review.

6.5. Safety

6.5.1. System Safety Requirements

In the initial phases of the mission integration effort, regulations and instructions that apply to spacecraft design and processing are reviewed. Not all safety regulations will apply to a particular mission integration activity. Tailoring the range requirements to the mission unique activities will be the first step in establishing the safety plan.

Before a spacecraft arrives at the processing site, the payload organization must provide the cognizant range safety office with certification that the system has been designed and tested in accordance with applicable safety requirements (e.g., AFSPCM 91-710 for CCAFS and VAFB). Spacecraft must also comply with the specific payload processing facility safety requirements. NGIS will provide the customer assistance and guidance regarding applicable safety requirements.

It cannot be overstressed that the applicable safety requirements should be considered in the earliest stages of spacecraft design. Processing and launch site ranges discourage the use of waivers and variances. Furthermore, approval of such waivers cannot be guaranteed.

6.5.2. System Safety Documentation

For each Minotaur mission, NGIS acts as the interface with Range Safety. In order to fulfill this role, NGIS requires safety information from the payload. For launches from either the Eastern or Western Ranges, AFSPCM 91-710 provides detailed range safety regulations. To obtain approval to use the launch site facilities, specific data must be prepared and submitted to NGIS. This information includes a description of each payload hazardous system and evidence of compliance with safety requirements for each system. Drawings, schematics, and assembly and handling procedures, including proof test data for all lifting equipment, as well as any other information that will aid in assessing the respective systems should be included. Major categories of hazardous systems are ordnance devices, radioactive materials, propellants, pressurized systems, toxic materials, cryogenics, and RF radiation. Procedures relating to these systems as well as any procedures relating to lifting operations or battery operations should be prepared for safety review submittal. NGIS will provide this information to the appropriate safety offices for approval.

7. GROUND AND LAUNCH OPERATIONS

Minotaur ground and launch operations processing minimizes the handling complexity for both launch vehicle and payload. All launch vehicle motors, parts and completed subassemblies are delivered to the Minotaur Processing Facility (MPF) from either NGIS' Chandler production facility, the assembly/motor vendor, or the Government. Ground and launch operations are conducted in three major phases:

- a. **Launch Vehicle Integration** — Assembly and test of the Minotaur launch vehicle.
- b. **Payload Processing/Integration** — Receipt and checkout of the payload, followed by integration with the Minotaur launch vehicle interface, verification of those interfaces and payload encapsulation.
- c. **Launch Operations** — Includes transport to the launch pad, final integration, checkout, arming and launch.

Figure 7-1 depicts the typical flow of hardware from the factory to the launch site.

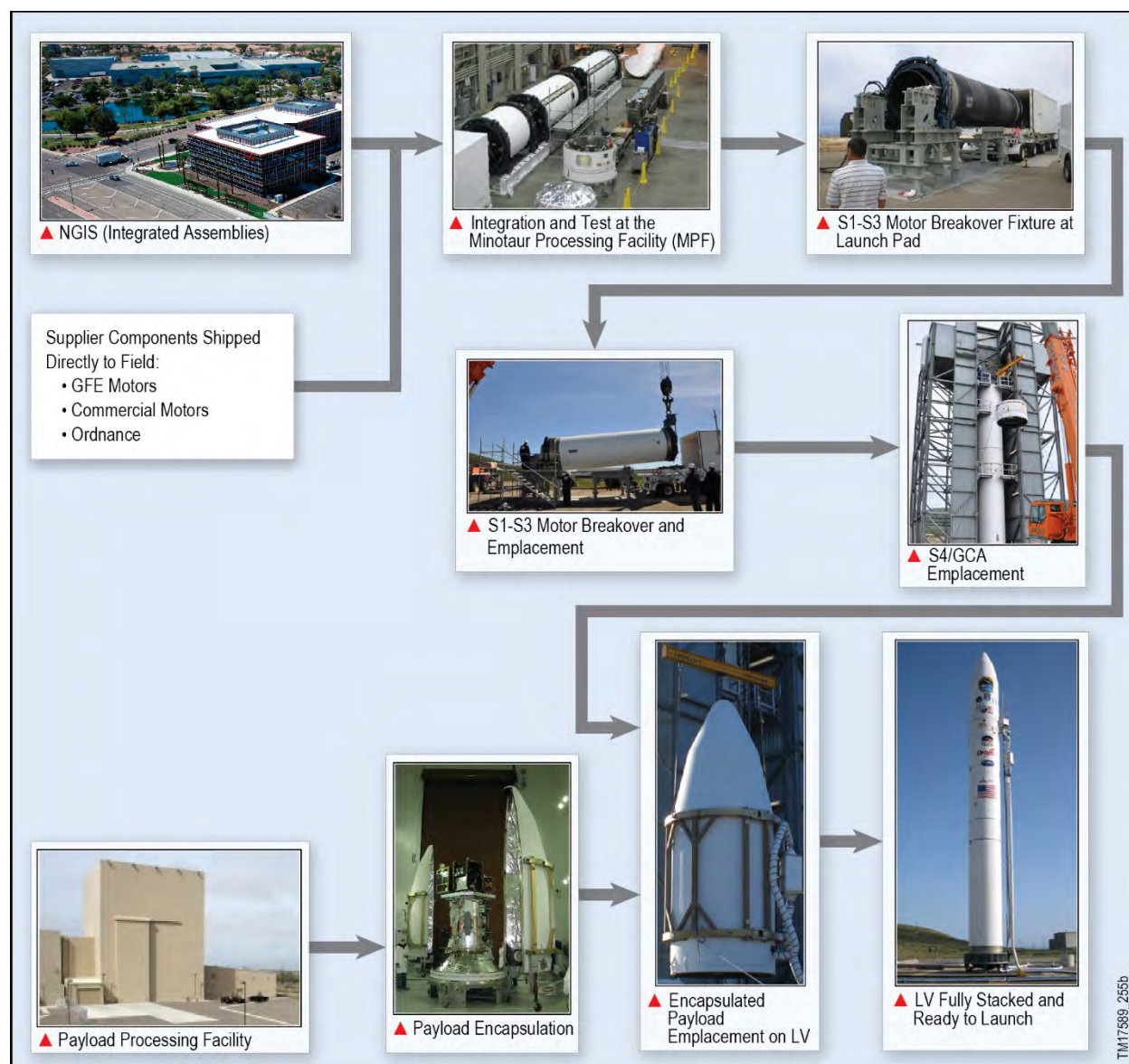

Figure 7-1. Hardware Flow – Factory to Launch Site

7.1. Launch Vehicle Integration Overview

NGIS utilizes the same fundamental integration and process flow for all launch vehicles in the Minotaur family. A flowchart of the launch vehicle integration at the MPF is shown in Figure 7.1-1 for a VAFB Minotaur IV launch. The flow to accommodate other Minotaur configurations or other launch facilities is similar and modified as required. The timeline described in this section pertains to a nominal launch campaign. Figure 7.1-2 shows the Minotaur hardware and support equipment undergoing integration at the MPF.

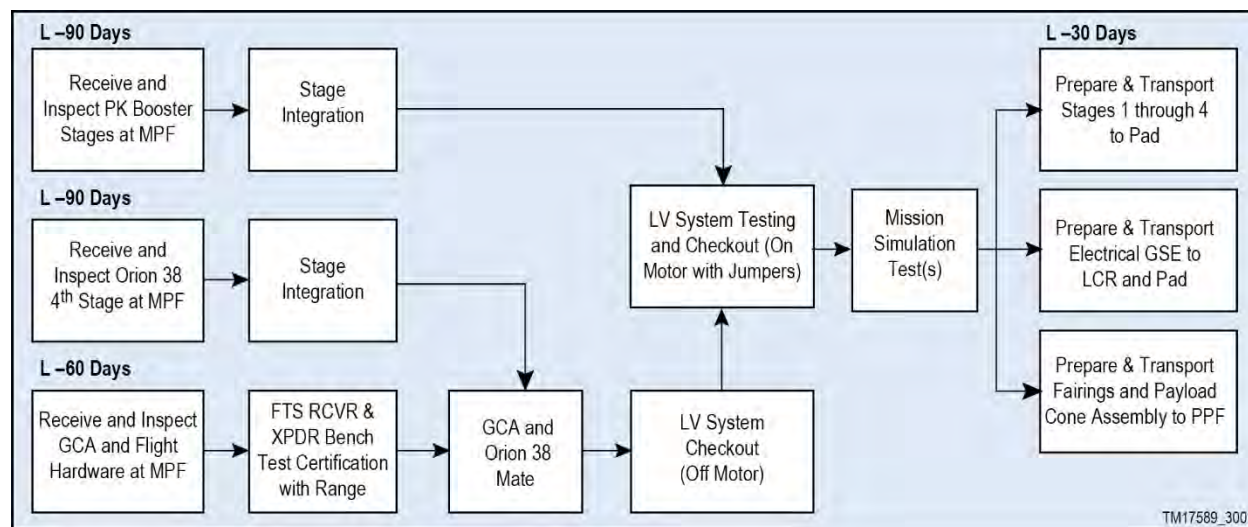

Figure 7.1-1. Launch Vehicle Processing Flow at the MPF

7.1.1. Planning and Documentation

Minotaur integration and test activities are controlled by a comprehensive set of Work Packages (WPs) that describe and document every aspect of integrating and testing the Minotaur launch vehicle and its payload. All testing and integration activities are scheduled by work package number on an activity schedule that is updated and distributed daily during field operations. This schedule is maintained by NGIS and serves as the master document communicating all activities planned at the field site. The schedule contains notations regarding the status of the work package document and hardware required to begin the operation. Mission-specific work packages are created for mission-unique or payload-specific procedures. Any discrepancies encountered are recorded on a Non-Conformance Report and dispositioned as required. All activities are in accordance with NGIS' ISO 9001 certification.

7.1.2. Guidance and Control Assembly Integration and Test Activities

The Guidance and Control Assembly (GCA) will undergo system level testing at NGIS' Chandler facility prior to being shipped to the field site. The GCA and the upper stage motor are then delivered to the MPF located at VAFB. Upon arrival at VAFB these assemblies will undergo a thorough inspection and subsystem level checkout. At this time



Figure 7.1-2. Minotaur Launch Vehicle Integration at MPF

range certification of Range Tracking System (RTS) and Flight Termination System (FTS) devices will be performed at both the component and in-vehicle testing level. After the completion of subsystem level testing, the motor is integrated into the GCA to form the GCA/motor assembly.

7.1.3. PK Motor Integration and Test Activities

The PK motors are delivered to the MPF where they undergo checkout, integration, and testing. These activities include ordnance and raceway installation, as well as steering and phasing tests.

7.1.4. Mission Simulation Tests

NGIS will run at least two Mission Simulation Tests (MST) to verify the functionality of launch vehicle hardware, and software. The Mission Simulation Tests use the actual flight software and simulate a “fly to orbit” scenario using simulated Inertial Navigation System (INS) data. This allows the test to proceed throughout all mission phases and capture vehicle performance data. The data will be compared to previous MSTs performed in the factory using the same flight software and hardware. NGIS developed PK Thrust Vector Actuator (TVA) simulators are used to perform all mission simulations. These components provide a realistic assessment of booster performance during the testing operations. After a thorough data review of all telemetry parameters, the test configuration is disassembled and prepared for payload integration.

7.1.5. Launch Vehicle Processing Facilities

The Minotaur Processing Facility (MPF), Building 1900, at VAFB is a 48,000 sq. ft facility used primarily for LV processing prior to transporting the LV to the appropriate launch site or range for that mission. For missions out of VAFB, the MPF has adequate floor space and infrastructure to support concurrent launch vehicle and payload processing. The MPF is shown in Figure 7.1.5-1. Should the MPF be utilized for payload processing, it is expected that the payload and Minotaur launch vehicle would be processed in separate sections of the High Bay area.



Figure 7.1.5-1. Minotaur Processing Is Performed at the MPF at VAFB

The MPF has infrastructure capability to support payload processing requirements in terms of security, electrical and communications service, overhead crane, and a temperature and humidity controlled environment. High Cleanliness operations are discussed further in 8.2.3.1 as required per the mission and particle containment requirements.

7.2. Payload Processing/Integration

Payloads typically undergo initial checkout and preparation for launch at a Payload Processing Facility (PPF), which can be either government provided or commercial facility. After arrival at the PPF (see Figure 7.2-1), the payload completes its own independent verification and checkout prior to beginning integrated processing with the Minotaur launch vehicle. When integrated processing is ready to commence, the Minotaur fairing and Payload Adapter Module (PAM) are delivered to the payload processing facility. The payload is mounted to the PAM and then encapsulated by the fairing, as shown in Figure 7.2-2. The encapsulated assembly is then shipped in the vertical configuration to the launch site, as shown in Figure 7.2-3, where it will undergo pre-stack verification test. Together, the fairing and PAM provide a sealed assembly which protects the payload during transport and launch.

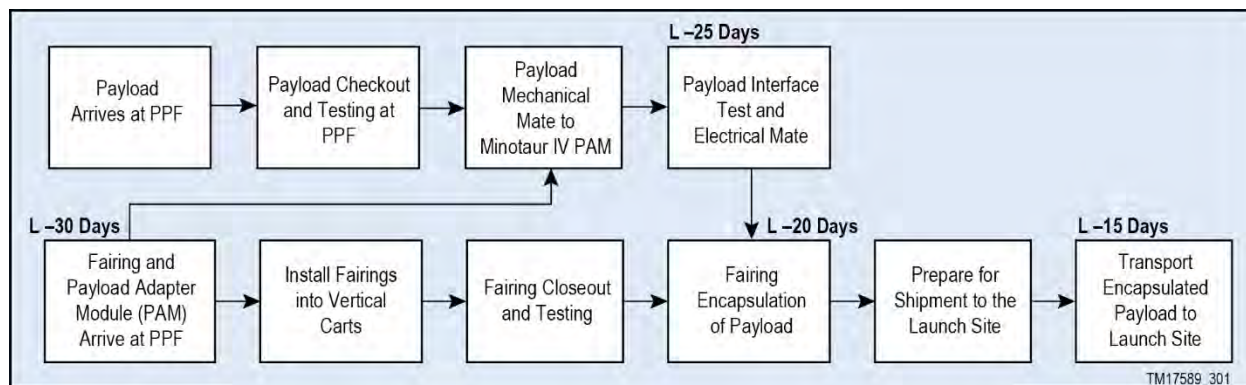

Figure 7.2-1. Payload Processing and LV Integration Flow at the PPF

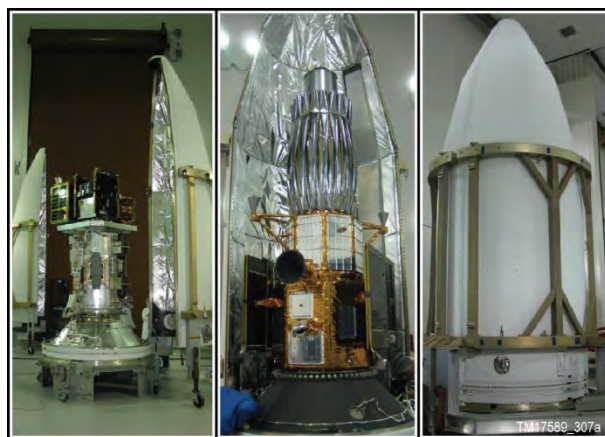

Figure 7.2-2. Payload Encapsulation at the PPF



Figure 7.2-3. Encapsulated Payload Transport to the Launch Site

7.2.1. Payload Propellant Loading

Payloads utilizing integral propulsion systems with propellants such as hydrazine can be loaded and secured through coordinated OSP arrangements. This is a non-standard service.

7.3. Launch Operations

At the completion of activities at the MPF and PPF, the final phase of the Launch campaign is entered. This begins with the stacking of the booster stages and culminates with the launch of the Minotaur and payload. A notional launch operations flow chart is shown in Figure 7.3-1. The L-minus dates may vary from mission to mission depending on vehicle configuration and other range commitments. Launch operations activities are described in more detail in the subsections to follow.

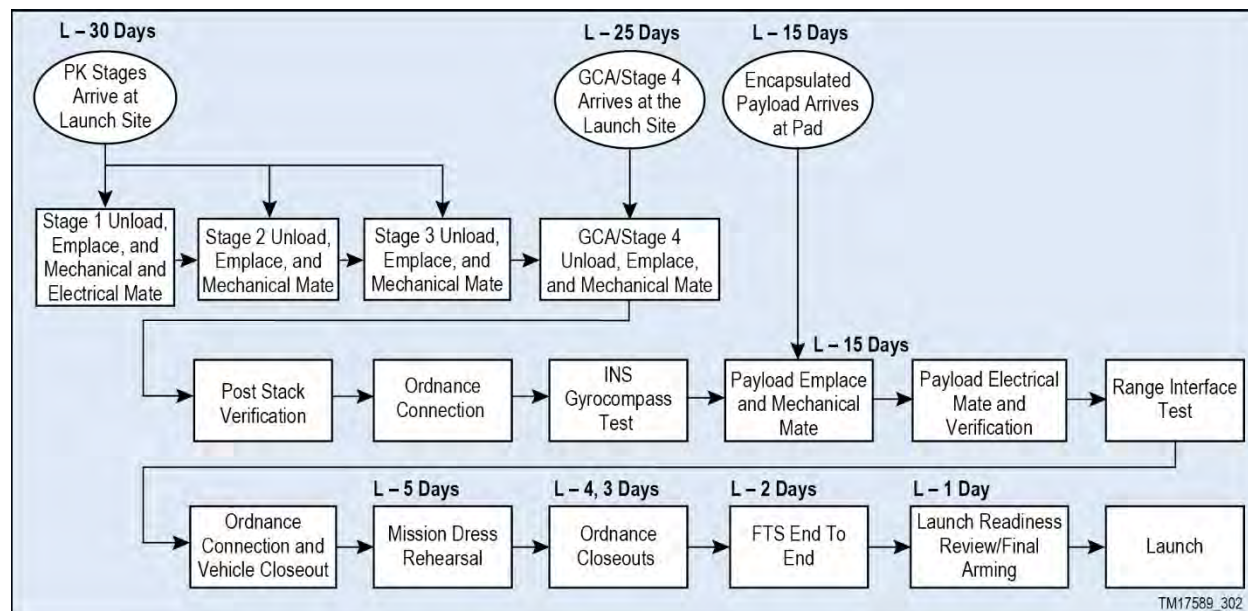

Figure 7.3-1. Minotaur IV Launch Site Operations

7.3.1. Booster Assembly Stacking/Launch Site Preparation

After completion of the launch vehicle testing at the MPF, the booster stages and the GCA/motor assembly are transported to the launch facility.

Prior to the arrival of the PK boosters, the site is prepared for launch operations with the installation of the launch stand adapter.

Each PK motor is individually transported down to the launch site. Once a motor arrives at the launch site, it is rolled off the transporter and then rotated into a vertical configuration. It is then lifted and emplaced onto the launch stand adapter. This process is repeated for each PK stage.

The GCA/motor assembly is shipped in the vertical configuration to the launch site, where it is emplaced on top of the PK motor stack. Stacking operations are shown in Figure 7.3.1-1 as performed at VAFB SLC-8 for a Minotaur IV mission.

7.3.2. Final Vehicle Integration and Test

After successful completion of payload mate and fairing closeout, the encapsulated payload is transported to the pad in a vertical configuration and then lifted atop the booster assembly (see Figure 7.3.1-1). Final post-mate checks of the booster assembly and front section assembly interface are conducted, followed by a final systems verification test. At this point the vehicle is ready for final Range interface tests.

7.3.3. Launch Vehicle Arming

Following final vehicle testing, the launch vehicle is armed and the pad is cleared for launch. The majority of these arming activities occur at L-1 day and bring the Minotaur launch vehicle nearly to its launch day configuration. L-1 day is also typically the last opportunity for payload access. The last remaining arming steps (final arming) occur mid-way during the countdown on launch day.

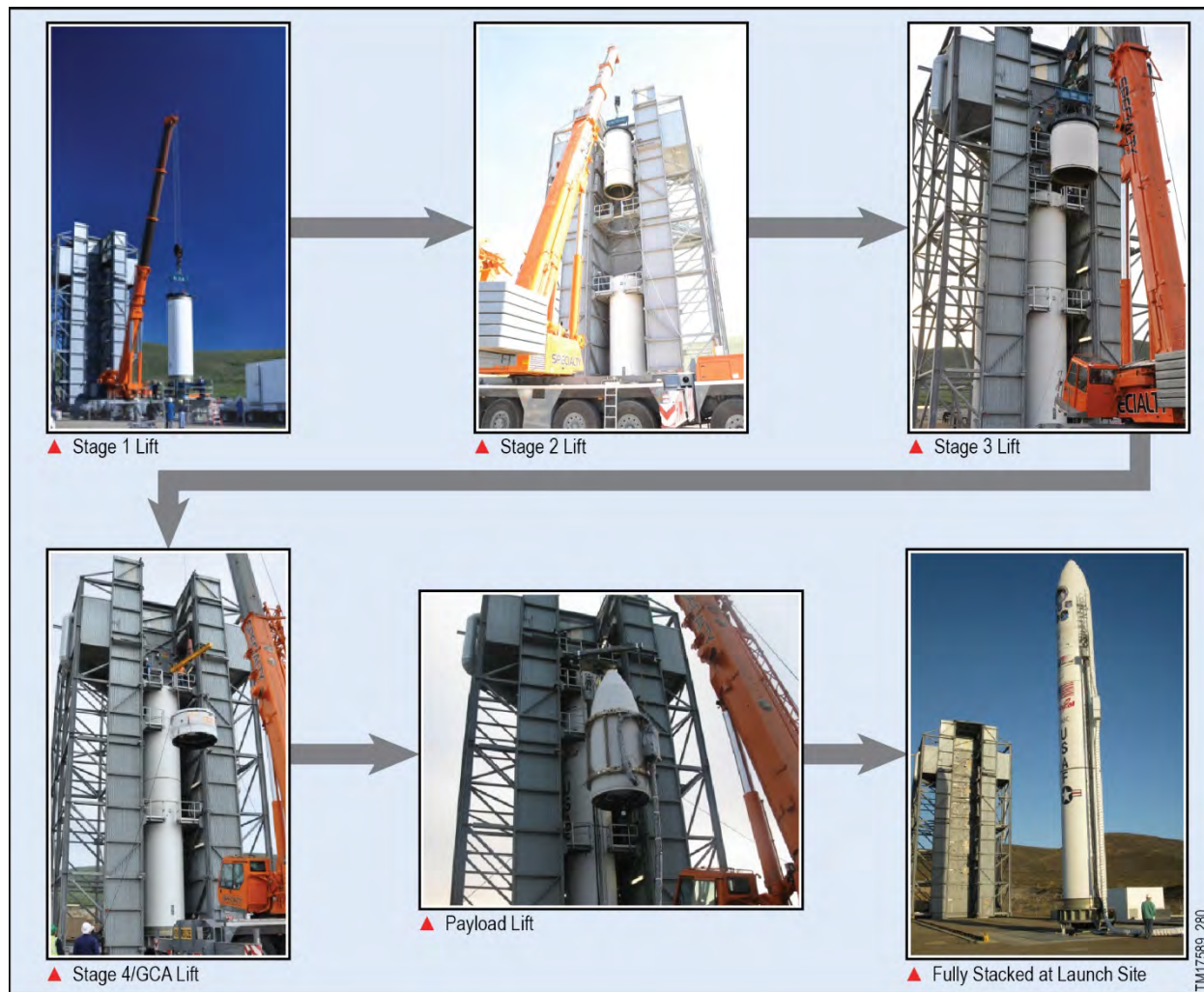

Figure 7.3.1-1. Minotaur Uses Vertical Integration for Each Booster Stage, the Guidance Control Assembly, and the Encapsulated Payload Assembly

7.3.4. Launch

The typical Minotaur final countdown procedure commences at 5 hours prior to the required launch time. Figure 7.3.4-1 describes the nominal Minotaur launch day flow. These activities methodically transition the vehicle from a safe state to that of launch readiness. Payload tasks, as necessary, are included in the countdown procedure and are coordinated by the Minotaur Launch Conductor. The Minotaur IV is shown ready for launch in Figure 7.3.4-2.

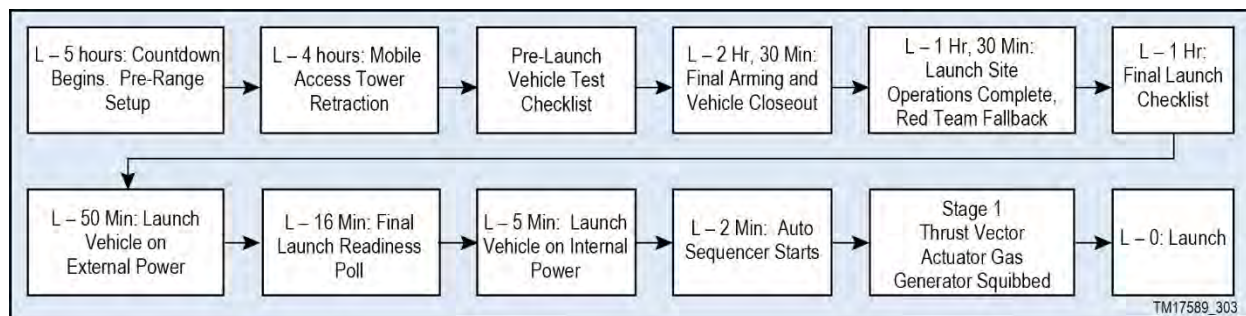

Figure 7.3.4-1. Notional Minotaur Countdown Timeline

7.3.5. Launch Control Organization

The Launch Control Organization is split into two groups: the Management group and the Technical group. The Management group consists of senior range personnel and Mission Directors/Managers for the launch vehicle and payload who provide authority to proceed at selected points in the countdown. The Technical Group consists of the Launch Vehicle, Payload and Range personnel responsible for execution of the launch operation, to include data review and launch readiness assessment. The Payload's members of the technical group are engineers who provide technical representation in the control center. The Launch Vehicle's members of the technical group are engineers who prepare the Minotaur for flight, review and assess data that is displayed in the Launch Control Room (LCR) and provide technical representation in the LCR and in the Launch Operations Control Center (LOCC). The Range's members of the technical group are personnel that maintain and monitor the voice and data equipment, tracking facilities and all assets involved with RF communications with the launch vehicle. In addition, the Range provides personnel responsible for the Flight Termination System monitoring and commanding.



Figure 7.3.4-2. Minotaur IV Prepared for Launch

7.3.6. Launch Rehearsals

Two rehearsals are conducted prior to each launch.

The first is conducted at approximately L-10 days and is used to acquaint the launch team with the communications systems, reporting, problem solving, launch procedures and constraints, and the decision making process. The first rehearsal is communications only (i.e., the Minotaur launch vehicle and payload are not powered on and range assets are not active). It is typically a full day in duration and consists of a number of countdowns performed using abbreviated timelines, clock jumps, and off-nominal situations. All aspects of the team's performance are exercised, as well as hold, scrub, and recycle procedures. The operations are critiqued and the lessons learned are incorporated prior to the Mission Dress Rehearsal (MDR) at L-5 days (typical). The MDR is the final rehearsal prior to the actual launch day operation. It will ensure that problems encountered during the first rehearsal have been resolved. The MDR exercises the entire 5 hour Minotaur countdown procedure and simulated post launch events. The Launch Vehicle is powered for this rehearsal and range assets perform operations as they would on launch day. There are no planned off-nominal events, however the team will react to real world anomalies as they would on launch day. MDR ends with successful completion of the countdown procedure.

All Customer personnel involved with launch day activities participate in both rehearsals.

This page left intentionally blank.

8. OPTIONAL ENHANCED CAPABILITIES

The OSP launch service is structured to provide a baseline vehicle configuration which is then augmented with optional enhancements to meet the unique needs of individual payloads. The baseline vehicle capabilities are defined in the previous sections and the optional enhanced capabilities are defined below. The enhanced options allow customization of launch support and accommodations to the Minotaur designs on an efficient, "as needed" basis.

8.1. Separation System and Optional Mechanical Interfaces

Several different types of optional separation systems and mechanical interfaces are available through NGIS. Further details can be found in Sections 5.2.4 and 5.2.5.

8.2. Conditioned Air

Conditioned air is included in the baseline vehicle cost and was described previously in Section 4.6.1. The Nitrogen Purge and Enhanced Contamination Control enhancements complement this capability as described in the enhancements Section 8.3 and 8.6.

8.3. Nitrogen Purge

Clean, dry gaseous nitrogen (GN_2) purge meeting Grade B specifications as defined in MIL-P-27401C can be provided to the payload in a Class 10,000 environment for continuous purge of the payload after fairing encapsulation until final payload closeouts (non-fly away) or until lift-off (flyaway configuration shown in Figure 8.3-1). This enhancement uses a flow regulated nitrogen ground supply connected to the fairing. The nitrogen flow control regulator ensures the purge is supplied at a minimum flow rate of 5 standard cubic feet per minute with a capability of up to 8 standard cubic feet per minute. A manifold mounted to the inside of the fairing wall feeds lines up the fairing wall to purge points of interest on the payload. Purge nozzles can be positioned on the fairing wall and pointed at the payload instrument. Alternatively, a fly away configuration can be used where the purge line connects to a manifold on the payload and is pulled free during fairing separation. This continuous purge can be supplied from payload encapsulation through launch, including during transport to the pad.

8.4. Additional Access Panel

As already discussed in Section 5.1.3, additional doors of the same size and configuration as the standard single access door can be provided. The location of the fairing access door is documented within



Figure 8.3-1. GN_2 Purge Interface To Minotaur Fairing (Flyaway at Liftoff)



Figure 8.4-1. Example Location and Size of Additional Access Panel

the mission-specific ICD. The allowable access door envelopes are shown in Figure 5.1.3-1. Required door locations outside the allowable envelope as shown in Figure 8.4-1 are evaluated on a mission-specific basis. Other fairing access configurations, such as small circular access panels, can be provided as non-standard, mission-specific enhancements. Additional mission-specific effort can be minimized if a previously flown access door configuration is chosen.

8.5. Enhanced Telemetry

Enhanced telemetry provides for mission specific instrumentation and telemetry components to support additional payload, LV, or experiment data acquisition requirements. This enhancement provides a dedicated telemetry link with a baseline data rate of 2 Mbps. Additional instrumentation or signals such as strain gauges, temperature sensors, accelerometers, analog and digital data can be configured to meet mission specific requirements. This capability was successfully demonstrated on the first five Minotaur IV launches. Typical enhanced telemetry instrumentation includes accelerometers (ECA) and microphones (ECM) intended to capture high frequency transients such as shock and random vibration. A sample of the enhanced telemetry instrumentation location on the Minotaur 92" payload fairing is provided in Figure 8.5-1.

8.6. Enhanced Contamination Control

To meet the requirement for a low contamination environment, NGIS uses existing processes developed and demonstrated on the Minotaur, Taurus, and Pegasus programs. These processes are designed to minimize out-gassing, supply a Class 10,000 clean room environment, assure a high cleanliness payload envelope, and provide a HEPA-filtered, controlled humidity environment after fairing encapsulation. NGIS leverages extensive payload processing experience to provide flexible, responsive solutions to mission-specific payload requirements (Figure 8.6-1).

8.6.1. Low Outgassing Materials

NGIS' existing high cleanliness design and integration processes ensure that all materials used within

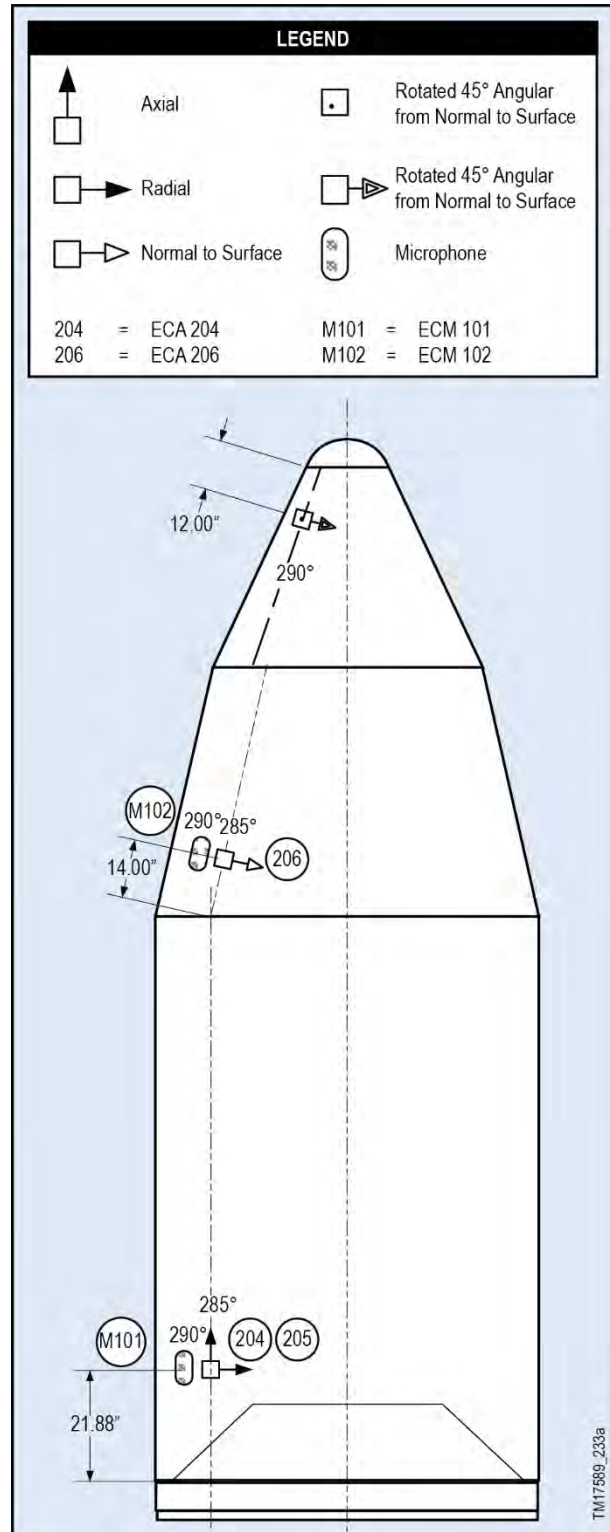

Figure 8.5-1. Representative Minotaur 92" Enhanced Instrumentation Locations (Fairing Only)

the encapsulated volume have outgassing characteristics of less than 1.0% Total Mass Loss (TML) and less than 0.1% Collected Volatile Condensable Mass (CVCM) in accordance with ASTM E59. If materials within the encapsulated volume cannot meet low outgassing characteristics because of unique mission requirements, a contamination control plan is developed to ensure controls are in place to eliminate any significant effect on the payload.

8.6.2. High Cleanliness Integration Environment

With the enhanced contamination control option, the encapsulated payload element of the vehicle is processed in an ISO Standard 14644-1 Class 10,000 environment during all payload processing activities up to fairing encapsulation (ISO 7). The Payload Processing Facility (PPF) clean room (Figure 1.6.6-2) utilizes HEPA filtration units to filter the air and ensure hydrocarbon content is maintained at ≤ 15 ppm, with humidity maintained at 30-60% relative humidity. Depending on payload requirements, the clean room can also be certified as Class 100,000 (ISO 8) while still providing tighter environmental control than the standard high-bay environment, thereby streamlining access and payload processing.



Figure 8.6-1. Minotaur Team Has Extensive Experience in a Payload Processing Clean Room Environment

8.6.3. HEPA-Filtered Fairing Air Supply

With the enhanced contamination control option, the ECU continuously purges the fairing volume with clean filtered air while maintaining temperature, humidity, and cleanliness. NGIS' ECU incorporates a HEPA filtration unit along with a hydrocarbon filter adaptor to provide Class 10,000 (ISO 7) air and ensure hydrocarbon content is maintained at ≤ 15 ppm, with humidity maintained as stated in section 4.6.1. NGIS monitors the supply air for particulate matter via a probe installed upstream of the fairing inlet duct prior to connecting the air source to the payload fairing.

8.6.4. Fairing Surface Cleanliness

The inner surface of the fairing and exposed launch vehicle assemblies are cleaned to Visibly Clean Plus Ultraviolet cleanliness criteria which ensures no particulate matter visible with normal vision when inspected from 6 to 18 inches under 100 foot candle incident light, as well as when the surface is illuminated by black light at 3200 to 3800 Angstroms. Process and procedures for inspection and the bagging of material to preclude contamination during shipment to the field are in place.

8.7. Secure FTS

The Secure FTS (Figure 8.7-1) is achieved with the L-3 Cincinnati Electronics Model CRD-120/205 Launch Vehicle Command Receiver/Decoder that is compatible with the "High-Alphabet" range safety modulation format. The receiver uses a pre-stored code unique to each specific vehicle to issue configuration and

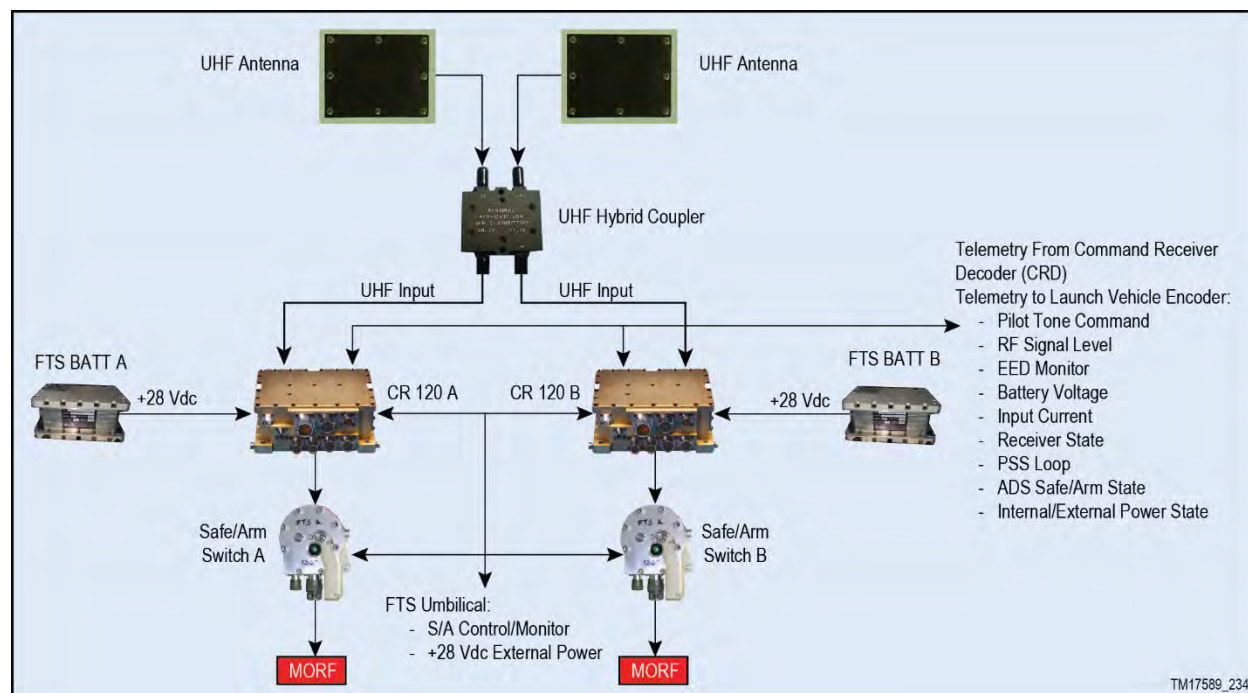

Figure 8.7-1. NGIS' Secure FTS System Block Diagram

termination commands. This provides an increased level of security over the standard FTS systems that use a basic 4 tone combination for receiver command and control.

The CRD-120/205 Launch Vehicle Command Receiver/Decoder (CRD) was designed specifically to operate on the Delta expendable space launch vehicles for range safety flight termination. This design incorporates redundancy in both hardware and software and High Reliability piece-parts (in accordance with ELV-JC-002D) to ensure reliable, fail-safe operation.

8.8. Over Horizon Telemetry

A Telemetry Data Relay Satellite System (TDRSS) interface can be added as an enhancement to provide real-time telemetry coverage during blackout periods with ground based telemetry receiving sites. TDRSS was successfully demonstrated on past Minotaur missions. The TDRSS telemetry system enhancement consists of a LCT2 TDRSS transmitter, an antenna (Figure 8.8-1), one RF switch, and associated ground test equipment. The RF switch is used during ground testing to allow for a test antenna to be used in lieu of the flight antennas. Near the time when telemetry coverage is lost by ground based telemetry receiving sites, the LV switches telemetry output to the TDRSS antenna and points the antenna towards a TDRSS satellite. The TDRSS relays the telemetry to the ground where it is then routed to the launch control room (Figure 8.8-2). A cavity backed or phased array antenna can be used depending on data rate requirements. The TDRSS system proposed includes the launch vehicle design, analysis, hardware and launch vehicle testing. For this option,

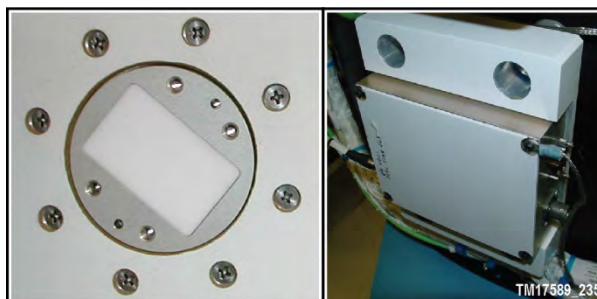

Figure 8.8-1. TDRSS 20W LCT2 Transmitter and Cavity Backed S-band Antenna

arrangements need to be made with NASA for system support and planning, management, scheduling, satellite usage, ground operations, and data processing.

8.9. Increased Insertion Accuracy

Enhanced insertion accuracy can be provided through the use of a Hydrazine Auxiliary Propulsion System (HAPS), shown in Figure 8.9-1. 6DOF analyses show the HAPS system provides a controlled impulse to achieve the accuracies shown in Table 8.9-1 (Insertion is for both apse and non-apse).

The HAPS propulsion system consists of a centrally mounted tank containing approximately 100 lbm of hydrazine and three fixed axial thrusters. The hydrazine tank contains an integral propellant management device which supports several zero gravity restarts. The system is integrated inside of a dedicated HAPS stage avionics structure that separates from the GCA. After final stage burnout and separation from the GCA, the HAPS hydrazine thrusters provide additional velocity for improved performance and precise orbit insertion. Alternatively, the system can be modified as a nonstandard enhancement to allow for integration into the existing GCA for increased vehicle accuracy without reducing payload volume within the fairing.

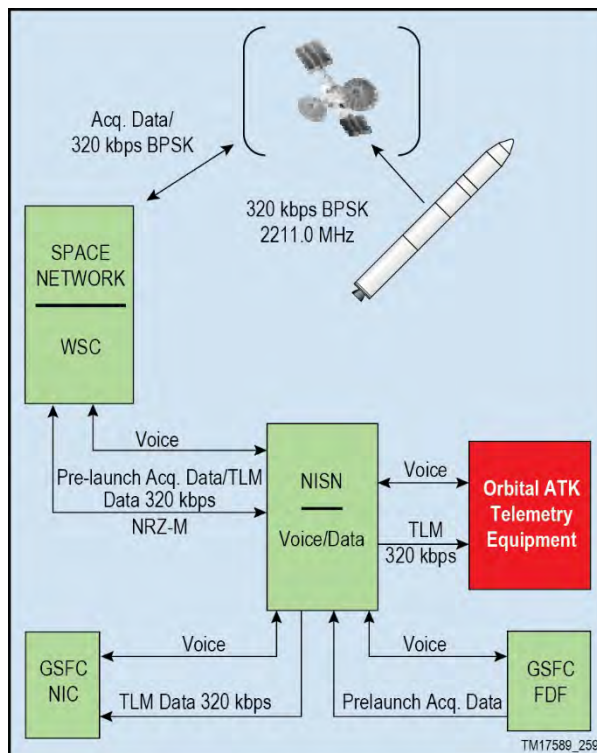

Figure 8.8-2. TDRSS Notional Telemetry Flow

Table 8.9-1. Enhanced Insertion Accuracy

Error Type	Tolerance
Insertion	<18.5 km (10 nmi) (3-σ)
Inclination	<0.05° (3-σ)

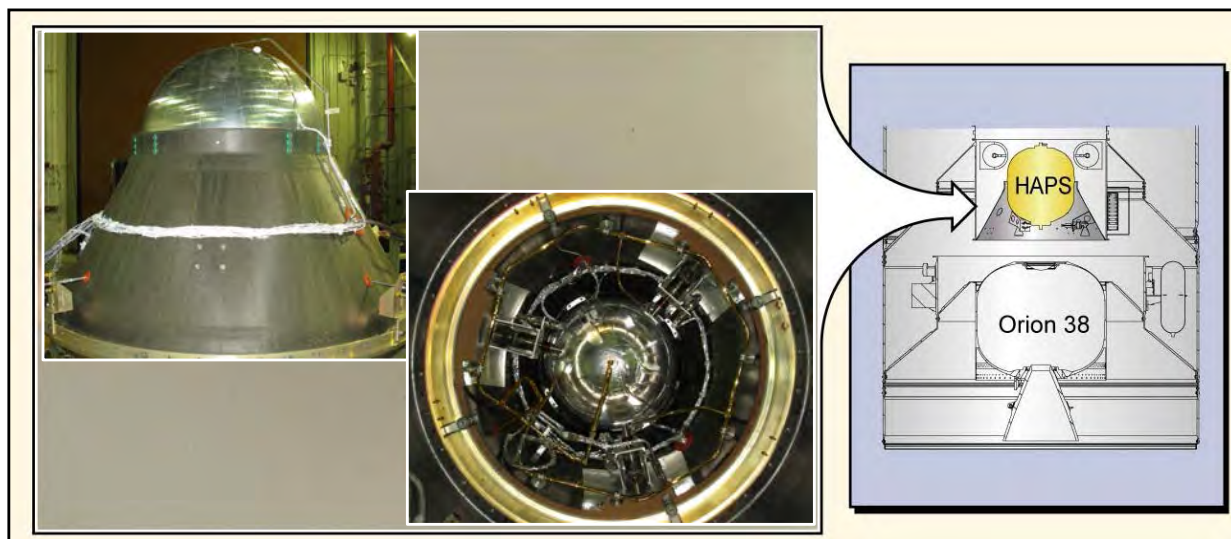

Figure 8.9-1. Hydrazine Auxiliary Propulsion System (HAPS) Used to Provide Insertion Accuracy

8.10. Payload Isolation System

NGIS offers a flight proven payload isolation system as a non-standard service. The Softride for Small Satellites (SRSS) was developed by Air Force Research Laboratory (AFRL) and CSA Engineering. It has successfully flown on numerous Minotaur missions. The typical configuration is shown in Figure 8.10-1. This mechanical isolation system has demonstrated the capability to significantly alleviate the transient dynamic loads that occur during flight. The isolation system can provide relief to both the overall payload center of gravity loads and component or subsystem responses. Typically the system will reduce transient loads to approximately 25% of the level they would be without the system. The exact results will vary for each particular spacecraft and with location on the spacecraft. Generally, a beneficial reduction in shock and vibration will also be provided. The isolation system does impact overall vehicle performance by approximately 9 to 18 kg (20 to 40 lb) and the available payload dynamic envelope by up to 5.08 cm (2.0 in.) axially and up to 2.54 cm (1.0 in.) laterally.

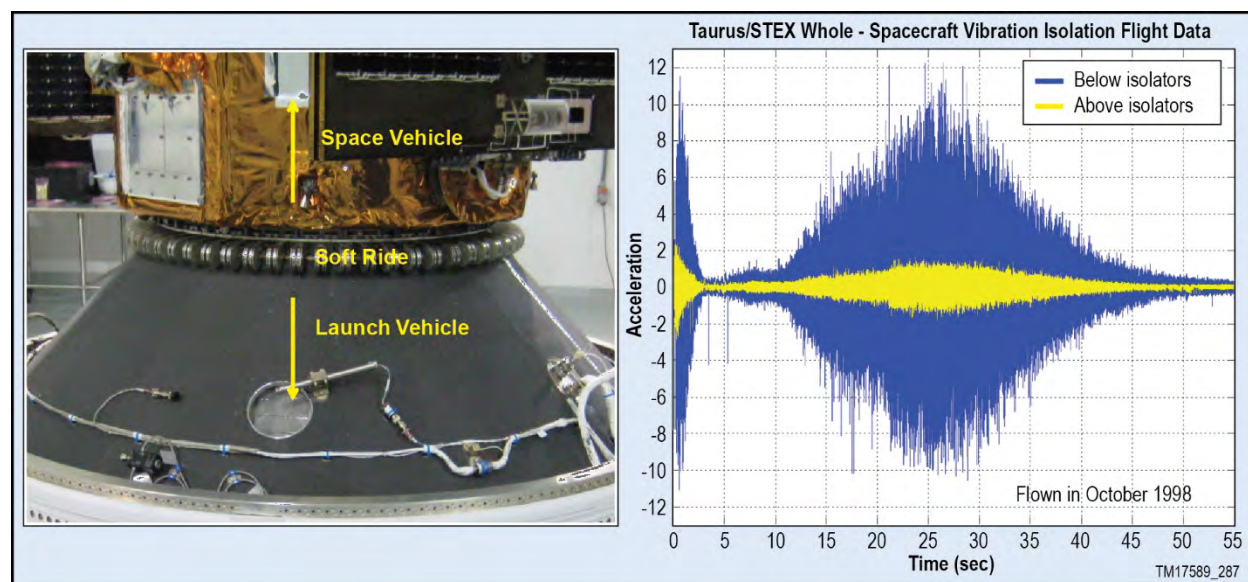

Figure 8.10-1. Minotaur Soft Ride Significantly Attenuates Peak LV Dynamic Environments

8.11. Orbital Debris Mitigation

For each mission, NGIS evaluates the orbit lifetime of all stages and hardware that reach Earth orbit. In the event that Minotaur hardware is left in an orbit that lasts for 25 years or longer, this enhancement is required to properly dispose and mitigate causality expectations of the hardware in accordance with AFI 91-217. Figure 8.11-1 shows the altitudes where Low Earth Orbits last for more than 25 years. For this enhancement, NGIS optimizes the orbital debris mitigation system to the specific mission requirements. For example, in some cases it might be more efficient to raise the final stage to an orbit in the LEO Disposal region. In other cases it would be best to lower the final stage to an orbit where natural forces can return the hardware to the Earth's atmosphere within 25 years. In some cases, deployment of a solar sail or tether may be required. NGIS will determine the optimal solution on a mission specific basis.

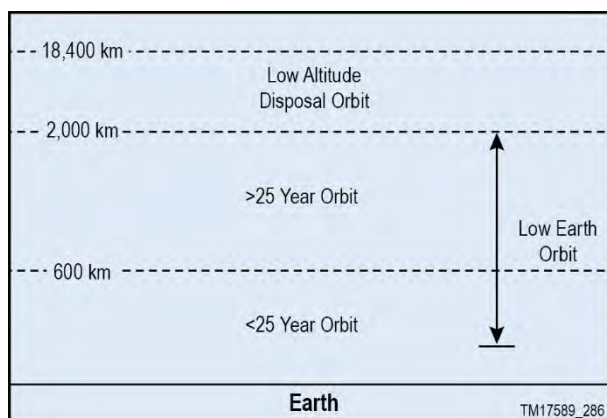

Figure 8.11-1. Operational and Disposal LEOs

8.12. Dual and Multi Payload Adapter Fittings

Details are provided in Section 5.2.4.2.

8.13. Enhanced Performance

Standard Minotaur performance capabilities can be enhanced to meet various mission demands. The modular design of NGIS' advanced avionics and mechanical structures is showcased by several vehicle variations that offer increased performance while maintaining the same level of reliability. Minotaur LVs are built on a solid foundation of heritage hardware and proven processes in manufacturing, engineering, quality, and management. Details are provided in Section 2.3.6.

8.14. Large Fairing

Details are provided in Section 5.1.2.

8.15. Hydrazine Servicing

Under this enhancement, NGIS provides hydrazine fueling service for the SV though a contract to United Paradyne Corporation (UPC). Previous 30SW rules placed restrictions on UPC's ability to use GFE equipment to provide hydrazine servicing to non-Government entities. This led UPC to develop and manufacture their own GSE and they now possess the ability to contract directly with NGIS. A typical propellant loading schematic is shown in Figure 8.15-1.

The scope of this enhancement includes the procurement of hydrazine fuel, the preparation of documentation for fueling operations, the support of safety and integrated operations meetings, the provision of equipment needed for SCAPE operation, including personal protection equipment (if necessary) and fuel transfer

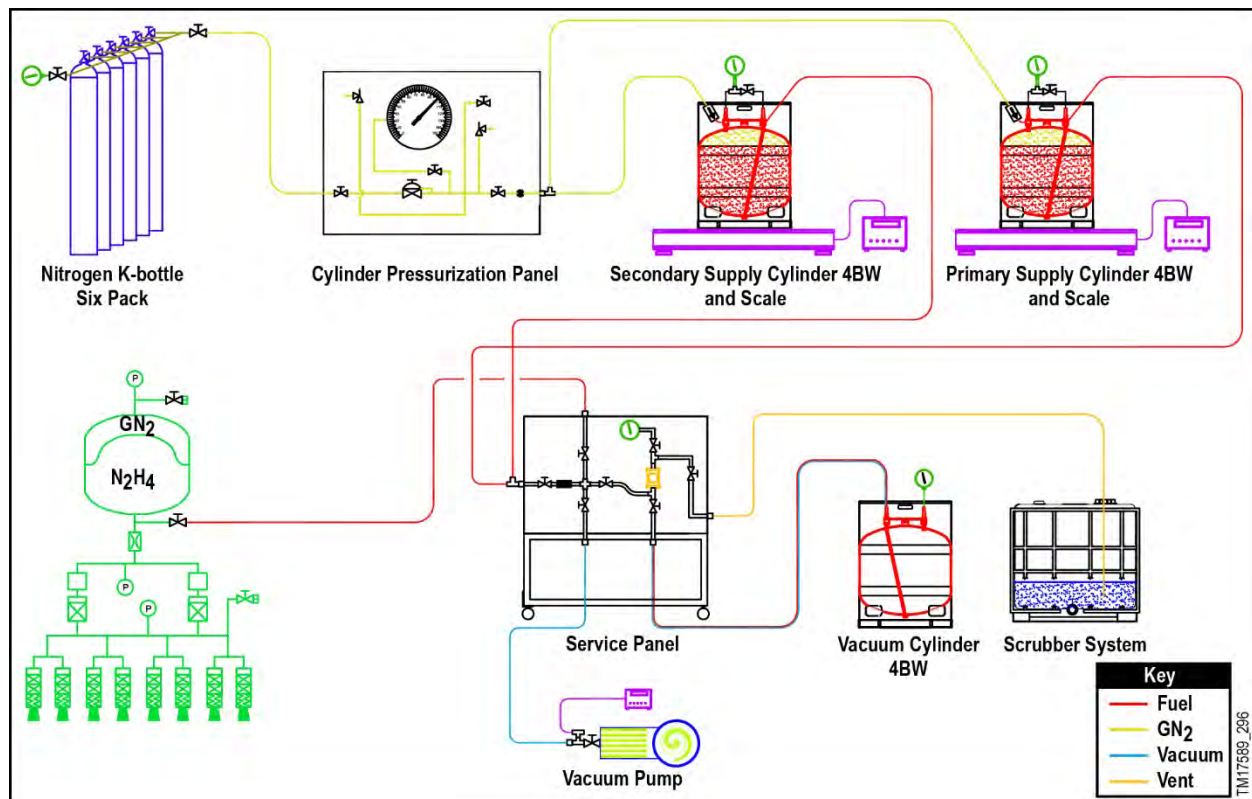

Figure 8.15-1. Typical Propellant Loading Schematic

cart, and all personnel required to conduct fuel loading operations. Emergency unloading operations can also be supported if desired. Figure 8.15-2 shows hardware used by UPC for hydrazine servicing.



Figure 8.15-2. UPC Provides Reliable and Demonstrated Hydrazine Servicing for Minotaur

8.16. Nitrogen Tetroxide Service

Under this enhancement, NGIS provides Nitrogen Tetroxide (NTO) loading service for the SV through a contract to UPC. The scope of this enhancement includes the procurement of NTO, the preparation of documentation for loading operations, the support of safety and integrated operations meetings, the provision of equipment needed for Self-Contained Atmospheric Protective Ensemble (SCAPE) operation, including personal protection equipment (if necessary) and NTO transfer cart, and all personnel required to conduct fuel loading operations. Emergency unloading operations can also be supported if desired.

8.17. Poly-Pico Orbital Deployer (P-POD)

When there is excess performance available on a Minotaur mission, there is an opportunity to fly one or more P-PODS. Small CubeSats deployed from customer provided P-PODs were successfully flown on multiple Minotaur missions. A single P-POD can deploy up to 3 CubeSats.

On Minotaur IV, the P-PODs are mounted on shock isolated plates located on the Orion 38 motor case (Figure 8.17-1) and are deployed in the aft direction following Stage 4 burnout. A standard pyro pulse from the launch vehicle is used to deploy the P-PODs. The Minotaur IV standard launch vehicle, with the Orion 38 fourth stage, is capable of deploying up to four P-PODs per mission. Due to their mounting location, P-PODs can be easily integrated to the launch vehicle on a fully non-interference basis from the primary

spacecraft, thus minimizing impacts to the primary mission spacecraft integration operations. This enhancement assumes the P-PODs are added to the manifest early enough in the contract that extensive rework is not required.

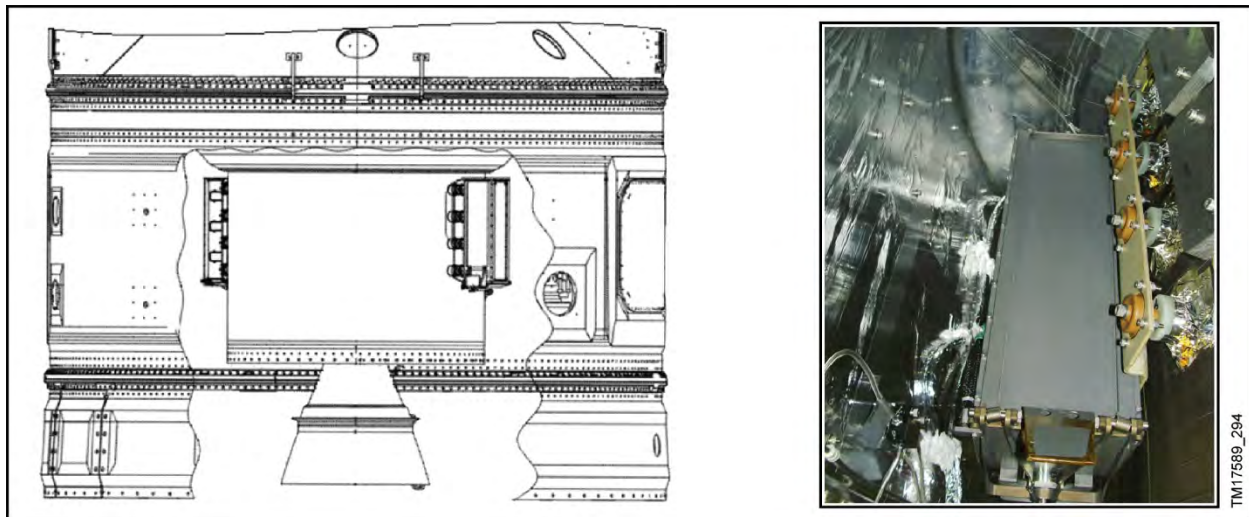

Figure 8.17-1. P-PODs Have Successfully Flown On Multiple Minotaur Missions

On other Minotaur configurations, P-PODS are mounted within the fairing volume either on their own wafer or as secondaries on NGIS-provided structures such as the DPAF, MPAF, or the STAR 37 cylinder where space has been set aside for such opportunities.

8.18. Suborbital Performance

The standard Minotaur IV configuration can be modified into the flight proven Minotaur IV Lite LV to meet various suborbital mission demands. The modular design of NGIS' advanced avionics and mechanical structures allows for modification while maintaining the same level of reliability. Minotaur IV Lite is built on a solid foundation of heritage hardware and proven processes in manufacturing, engineering, quality, and management.

Under the Suborbital Performance Modification Enhancement for Minotaur IV, the 4th stage Orion 38 motor is removed from the standard Minotaur IV. Minotaur IV Lite, shown in Figure 8.18-1, relies exclusively on the propulsive impulse of the three solid-propellant Peacekeeper motors (SR118, SR119, and SR120). Minotaur IV Lite has significant performance capability with the ability to launch payloads weighing up to 6600 lb on suborbital trajectories. In addition, Minotaur IV Lite can also be easily adapted to a wide variety of suborbital payloads by means of a custom payload adapter plate.

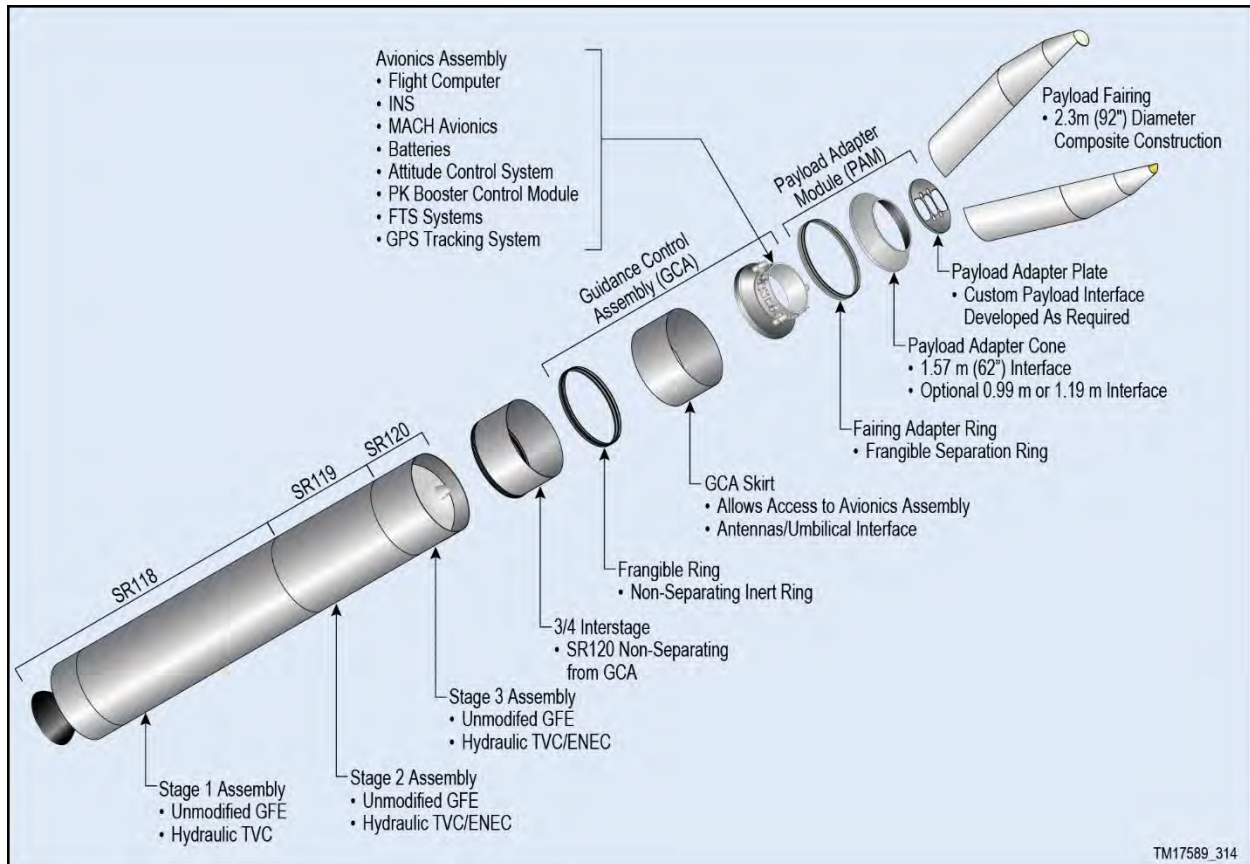

Figure 8.18-1. Expanded View of Minotaur IV Lite Configuration

8.19. Alternate Launch Locations

NGIS has extensive experience processing and launching out of multiple Government and commercial launch sites. Minotaur systems are designed to accommodate missions from multiple ranges with minimal dedicated infrastructure. The Minotaur flight safety systems and Range interface requirements are well documented and approved by multiple safety organizations. NGIS has experience working closely with various ranges to address the ground and flight safety requirements to ensure a safe and successful launch.

While VAFB is home to the Minotaur Processing Facility, the Minotaur system was designed from the beginning to launch from all four of the existing commercial spaceports: Spaceport Systems International's SLC-8 at VAFB, AAC's Kodiak Launch Complex in Alaska, Space Florida's LC-46 at CCAFS, and Mid-Atlantic Regional Spaceport's Pad 0B at Wallops Island, Virginia. KLC (Figure 8.19-1) and CCAFS (Figure 8.19-2) can support all of the Minotaur configurations including the larger variants without any significant gantry or infrastructure modifications. Minotaur can also support other ranges and austere sites as a non-standard service on a case-by-case basis.



Figure 8.19-1. Minotaur IV Vehicle Processing and Launch From KLC



Figure 8.19-2. Launch Complex 46 at CCAFS Supports All Minotaur Configurations

This page left intentionally blank.

APPENDIX A
PAYLOAD QUESTIONNAIRE

This page left intentionally blank.

SATELLITE IDENTIFICATION		
FULL NAME:		
ACRONYM:		
OWNER/OPERATOR:		
INTEGRATOR(s):		
SPACE CRAFT AND MIS- SION DESCRIPTION		
ORBIT INSERTION REQUIREMENTS*		
SPHEROID	<input type="checkbox"/> Standard (WGS-84, $R_e = 6378.137$ km) <input type="checkbox"/> Other:	
ALTITUDE	Insertion Apse: _____ ± _____ <input type="checkbox"/> nmi <input type="checkbox"/> km	Opposite Apse: _____ ± _____ <input type="checkbox"/> nmi <input type="checkbox"/> km
or...	Semi-Major Axis: _____ ± _____ <input type="checkbox"/> nmi <input type="checkbox"/> km	Eccentricity: _____ ≤ e ≤ _____
INCLINATION	_____ ± _____ deg	
ORIENTATION	Argument of Perigee: _____ ± _____ deg	Longitude of Ascending Node (LAN): _____ ± _____ deg
	Right Ascension of Ascending Node (RAAN): _____ ± _____ deg For Launch Date: _____	

* Note: Mean orbital elements

SPACECRAFT PHYSICAL DIMENSIONS	
STOWED CONFIGURATION	Length/Height: _____ <input type="checkbox"/> in <input type="checkbox"/> cm Diameter: _____ <input type="checkbox"/> in <input type="checkbox"/> cm cm Other Pertinent Dimension(s):
	Describe any appendages/antennas/etc which extend beyond the basic satellite envelope:
ON-ORBIT CONFIGURATION	Describe size and shape:

If available, provide dimensioned drawings for both stowed and on-orbit configurations.

SPACECRAFT MASS PROPERTIES*	
PRE-SEPARATION	Inertia units: <input type="checkbox"/> lb _m -in ² <input type="checkbox"/> kg-m ² Mass: _____ <input type="checkbox"/> lb _m <input type="checkbox"/> kg Ixx: _____ Xcg: _____ <input type="checkbox"/> in <input type="checkbox"/> cm Iyy: _____ Izz: _____ Ycg: _____ <input type="checkbox"/> in <input type="checkbox"/> cm Ixy: _____ Iyz: _____ Zcg: _____ <input type="checkbox"/> in <input type="checkbox"/> cm Ixz: _____
POST-SEPARATION (non-separating adapter remaining with launch vehicle)	Inertia units: <input type="checkbox"/> lb _m -in ² <input type="checkbox"/> kg-m ² Mass: _____ <input type="checkbox"/> lb _m <input type="checkbox"/> kg Ixx: _____ Xcg: _____ <input type="checkbox"/> in <input type="checkbox"/> cm Iyy: _____ Izz: _____ Ycg: _____ <input type="checkbox"/> in <input type="checkbox"/> cm Ixy: _____ Iyz: _____ Zcg: _____ <input type="checkbox"/> in <input type="checkbox"/> cm Ixz: _____

* Stowed configuration, spacecraft coordinate frame

SPACECRAFT SLOSH MODEL *	
SLOSH MODEL UNDER 0 g	Pendulum Mass: _____ <input type="checkbox"/> lb _m <input type="checkbox"/> kg Pendulum Length: _____ <input type="checkbox"/> ft <input type="checkbox"/> m Pendulum Xs: _____ <input type="checkbox"/> in <input type="checkbox"/> cm Attachment Ys: _____ <input type="checkbox"/> in <input type="checkbox"/> cm Point Zs: _____ <input type="checkbox"/> in <input type="checkbox"/> cm Natural Frequency of Fundamental Sloshing Mode (Hz): _____
SLOSH MODEL UNDER 1 g	Pendulum Mass: _____ <input type="checkbox"/> lb _m <input type="checkbox"/> kg Pendulum Length: _____ <input type="checkbox"/> ft <input type="checkbox"/> m Pendulum Xs: _____ <input type="checkbox"/> in <input type="checkbox"/> cm Attachment Ys: _____ <input type="checkbox"/> in <input type="checkbox"/> cm Point Zs: _____ <input type="checkbox"/> in <input type="checkbox"/> cm Natural Frequency of Fundamental Sloshing Mode (Hz): _____

ASCENT TRAJECTORY REQUIREMENTS	
Free Molecular Heating at Fairing Separation: (Standard Service: = 360 Btu/ft ² /hr)	<input type="checkbox"/> Btu/ft ² /hr FMH ≤ _____ <input type="checkbox"/> W/m ²
Fairing Internal Wall Temperature (Standard Service: = 200°F)	<input type="checkbox"/> deg F T ≤ _____ <input type="checkbox"/> deg C
Dynamic Pressure at Fairing Separation: (Standard Service: = 0.01 lb _f /ft ²)	<input type="checkbox"/> lb _f /ft ² q ≤ _____ <input type="checkbox"/> N/m ²
Ambient Pressure at Fairing Separation: (Standard Service: = 0.3 psia)	<input type="checkbox"/> lb _f /in ² P ≤ _____ <input type="checkbox"/> N/m ²
Maximum Pressure Decay During Ascent: (Standard Service: = 0.6 psia)	<input type="checkbox"/> lb _f /in ² /sec Δ P ≤ _____ <input type="checkbox"/> N/m ² /sec
Thermal Maneuvers During Coast Periods: (Standard Service: none)	

SPACECRAFT ENVIRONMENTS							
THERMAL DISSIPATION	Spacecraft Thermal Dissipation, Pre-Launch Encapsulated: _____ Watts Approximate Location of Heat Source: Thermal Control Provisions: (Paint, Tape, etc.):						
TEMPERATURE	Temperature Limits During Ground/Launch Operations: <table style="display: inline-table; vertical-align: middle;"> <tr> <td style="padding-right: 10px;">Max _____</td> <td><input type="checkbox"/> deg F</td> <td><input type="checkbox"/> deg C</td> </tr> <tr> <td style="padding-right: 10px;">Min _____</td> <td><input type="checkbox"/> deg F</td> <td><input type="checkbox"/> deg C</td> </tr> </table> (Standard Service is 55°F to 80°F)	Max _____	<input type="checkbox"/> deg F	<input type="checkbox"/> deg C	Min _____	<input type="checkbox"/> deg F	<input type="checkbox"/> deg C
	Max _____	<input type="checkbox"/> deg F	<input type="checkbox"/> deg C				
Min _____	<input type="checkbox"/> deg F	<input type="checkbox"/> deg C					
Component(s) Driving Temperature Constraint: Approximate Location(s):							
HUMIDITY	<table style="width: 100%; border: none;"> <tr> <td style="width: 50%; vertical-align: top;"> Relative Humidity: Max _____% Min _____% </td> <td style="width: 10%; text-align: center; vertical-align: middle;">or,</td> <td style="width: 40%; vertical-align: top;"> Dew Point: Max _____ <input type="checkbox"/> deg F <input type="checkbox"/> deg C Min _____ <input type="checkbox"/> deg F <input type="checkbox"/> deg C (Standard Service is 37 deg F) </td> </tr> </table>	Relative Humidity: Max _____% Min _____%	or,	Dew Point: Max _____ <input type="checkbox"/> deg F <input type="checkbox"/> deg C Min _____ <input type="checkbox"/> deg F <input type="checkbox"/> deg C (Standard Service is 37 deg F)			
Relative Humidity: Max _____% Min _____%	or,	Dew Point: Max _____ <input type="checkbox"/> deg F <input type="checkbox"/> deg C Min _____ <input type="checkbox"/> deg F <input type="checkbox"/> deg C (Standard Service is 37 deg F)					
NITROGEN PURGE	Specify Any Nitrogen Purge Requirements, Including Component Description, Location, and Required Flow Rate: (Nitrogen Purge is a Non-Standard Service)						
CLEANLINESS	Volumetric Requirements (e.g. Class 100,000): _____ Surface Cleanliness (e.g. Visually Clean): _____ Other: _____						
LOAD LIMITS	Ground Transportation Load Limits Axial ≤ ____g's Lateral ≤ ____g's						

ELECTRICAL INTERFACE	
Bonding Requirements:	
Are Launch Vehicle Supplied Pyro Commands Required? Yes / No	If Yes, magnitude: ____amps for ____msec (Standard Service is 10 amps for 100 msec)
Are Launch Vehicles Supplied? Yes / No Discrete Commands Required? Yes / No	If Yes, describe:
Is Electrical Access to the Satellite Required... After Encapsulation? Yes / No at Launch Site Yes / No	
Is Satellite Battery Charging Required... After Encapsulation? Yes / No at Launch Site? Yes / No	
Is a Telemetry Interface with the Launch Vehicle Flight Computer Required? Yes / No	
If Yes, describe:	
Other Electrical Requirements:	

Please complete attached sheet of required pass-through signals.

RF RADIATION	
Time After Separation Until RF Devices Are Activated:	
(Note: Typically, no spacecraft radiation is allowed from encapsulation until 30 minutes after liftoff.)	
Frequency: _____ MHz	Power: _____ Watts
Location(s) on Satellite (spacecraft coordinate frame):	
Longitudinal ____ <input type="checkbox"/> in <input type="checkbox"/> cm	Clocking (deg), Describe:
Longitudinal ____ <input type="checkbox"/> in <input type="checkbox"/> cm	Clocking (deg), Describe:

REQUIRED PASS-THROUGH SIGNALS							
Item #	Pin	Signal Name	From LEV	To Satellite	Shielding	Max Current (amps)	Total Line Resistance (ohms)
1							
2							
3							
4							
5							
6							
7							
8							
9							
10							
11							
12							
13							
14							
15							
16							
17							
18							
19							
20							
21							
22							
23							
24							
25							
26							
27							

